

# SIE300

"E" ECONOMY Series  
Solenoid / Pneumatic Valves

- 5/2, 5/3
- 26mm Body Width
- Sub-Base or Manifold Mounting Type
- Transition Flow 1000ℓ/min (5bar)

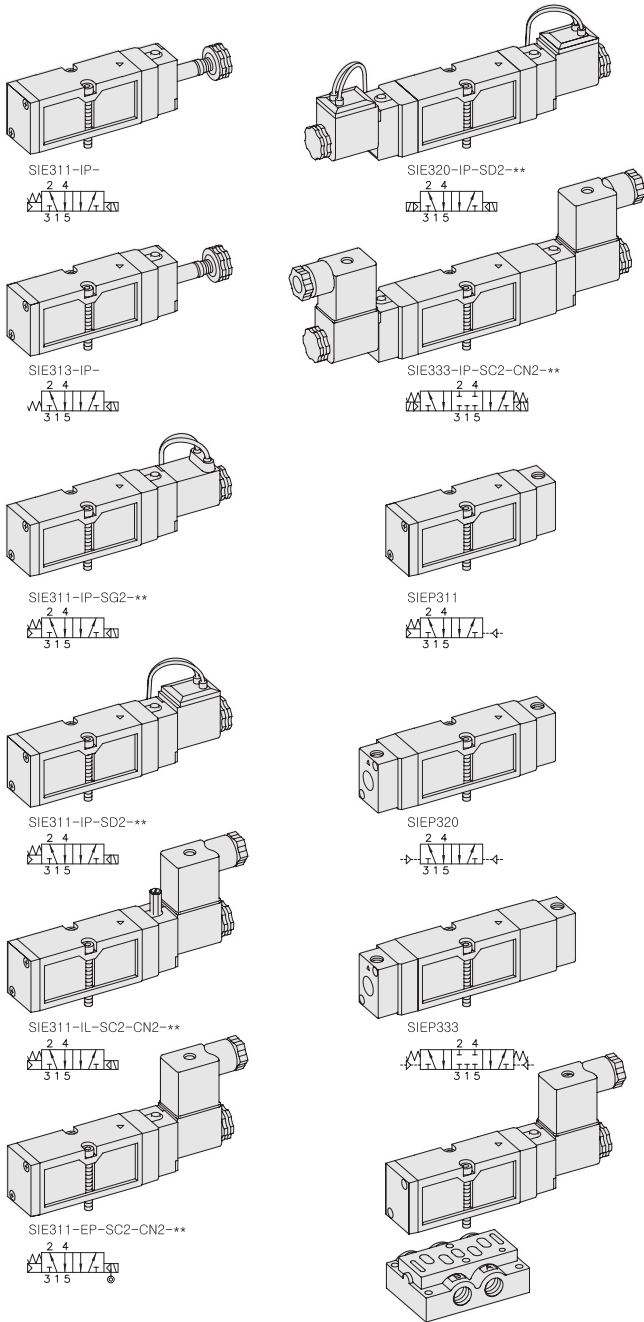

## SPECIFICATION

ITEM	SERIES FUNCTION	SOLENOID, PNEUMATIC	
		5 Port 2 Position	5 Port 3 Position
Fluids		Compressed Air & Inert Gases	
Pressure(bar)		1.5~10.0	2.0~10.0
Eff. Sectional Area(mm <sup>2</sup> )-5bar		18.0	11.0
Ambient & Fluid Temp.		5~60°C (41~140°F)	
Response Time(5bar)		25ms or Less	35ms or Less
Max. Working Frequency		5c/sec	3c/sec
Lubrication		Not Required(Use ISO VG32 #)	
Manual Override		Push Button(Standard), Lever Lock(Option)	
Coil Insulation Class		F-Class or Equivalent	
Permissible Voltage Variation		±10% of Rated Voltage	
Off Min. Residual Voltage		AC:20% or Less / DC:10% or Less	
Power Consumption		Holding-AC:5.5VA(60Hz) / DC:2.5W	

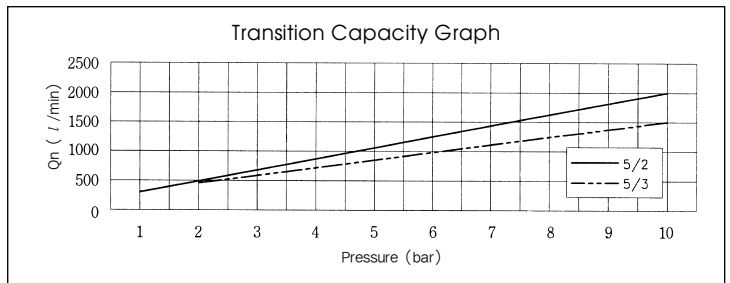

- ### The Material of Parts
- Valve Body : Die-Cast Aluminium
  - Spool : Aluminium
  - Seals : NBR
  - Spring : Stainless
  - Cap : Zinc Pressure Die-Cast
  - Pilot Parts : Glass Filled Nylon
  - Armature : Stainless Steel
  - Armature Seals : Viton

\* The specification on each item can be amended without any prenotice to improve a performance.  
\* The specification on each item can be different from actual specification.

## ORDERING NO.

**SIE3 1 1 - I P - SC2 - CN2 - A2**

Valve Series	Function	Return Method	Int/Ext. Pilot	Manual Operator	Solenoid Coil Type	Connector Type	Voltage
SIE3 : Solenoid Valve	1	5/2 Single	0 None	I Internal Pilot	0 None	0 None	0 None
	2	5/2 Double	1 Air+Spring	E External Pilot	SC2 3 Pin Connector Coil	CN2 Normal Connector	A2 AC 220V
	3	5/3 Closed Center	2 Air		SG2 Grommet/Flying Leads	CD2 Connector With LED	A1 AC 110V
	4	5/3 Open Center	3 Spring		SD2 Grommet/Flying Leads	CZ2 Connector With LED & Surge Suppressor	A4 AC 24V
	5	5/3 Pressure Center			With LED		D4 DC 24V
SIEP3 : Pneumatic Valve							D2 DC 12V

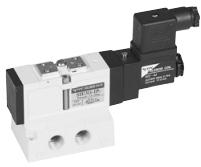
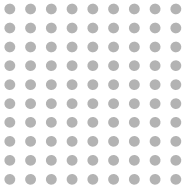

# Solenoid & Pilot Actuated Spool Valves

## 26mm Body Width

### 5Port 2Position Solenoid Valve

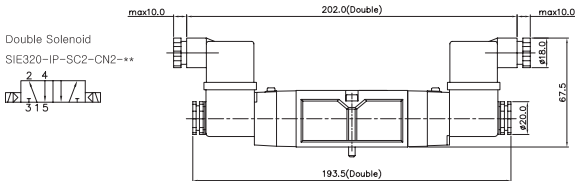
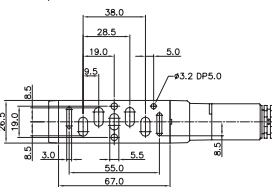
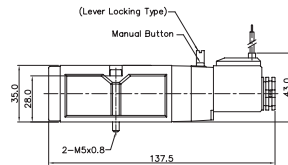
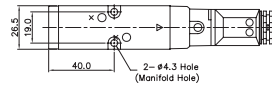
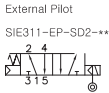
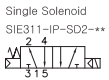

### 5Port 3Position Solenoid Valve

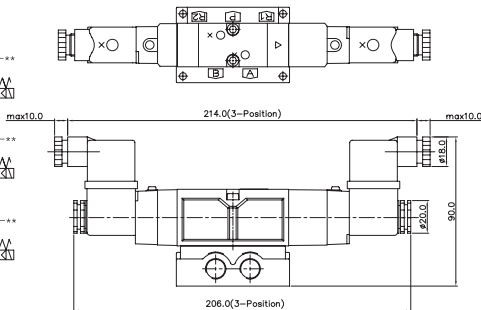
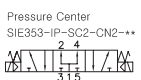
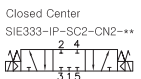

### 5Port 2Position Pneumatic Valve

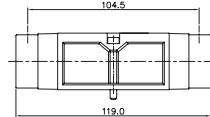
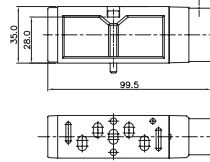
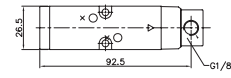
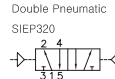
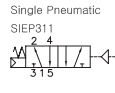

### 5Port 3Position Pneumatic Valve

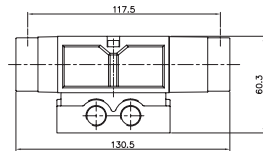
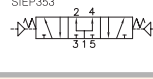
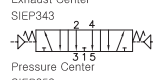
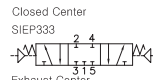

### Sub Base Ordering Code

SIB3		1		S	
Sub Base Series	Port & Thread	Function			
SIB3	0 None	S	Single Station Sub Base, 1/4 Port Without Pilot Ports		
SIE300 Solenoid Valve	1 G	SP	Single Station Sub Base, 1/4 Port With Pilot Ports		
	2 NPT	DB	Double Modular Sub Base, 1/4 Port Without Pilot Ports		
		DC8	Double Modular Sub Base, Ø8 One-Touch Fitting		
		E	End Cover, 1/4 Port		
		EB	End Blanking Cover		

## SIB30 SINGLE, DOUBLE SUB BASE

(SIE300 Solenoid & Pneumatic Valve Use Sub Base)

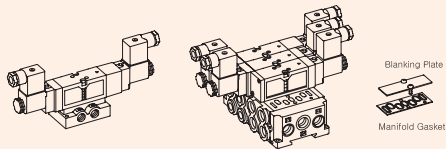

### Single Station Sub Base Dimension

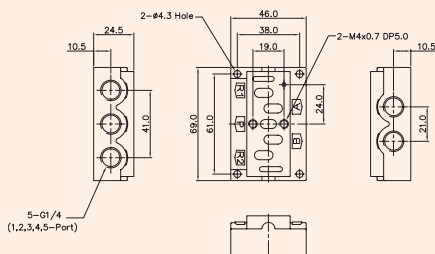

### Double Modular Sub Base Dimension

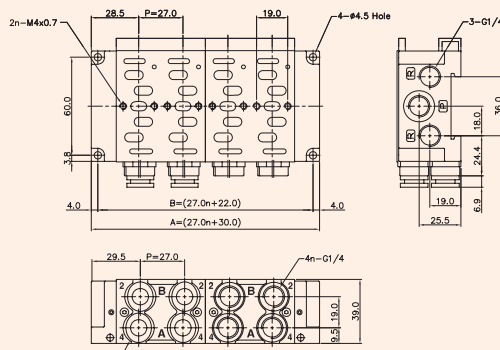

DOUBLE MODULAR SUB BASE DIMENSION		n-STATION				
ITEM	n	2	4	6	8	10
A		76.0	130.0	184.0	238.0	292.0
B		84.0	138.0	192.0	246.0	300.0

Ordering Code SIB30-BLK	Blanking Plate (Material: STS304)
	Manifold Gasket. (Material: NBR)
Ordering Code SIB31-E	End Cover, 1/4 (Material: AI)
Ordering Code SIB30-EB	End Blanking Cover (Material: AI)
Ordering Code SIB31-DB	Double Modular Sub Base, 1/4 (Material: AI)
Ordering Code SIB30-DC8	Double Modular Sub Base Ø8 one-touch fitting (Material: AI)