

NOTE 1)

No.	PART NAME	MATERIAL	Qt'y	SIZE	REMARK
01					

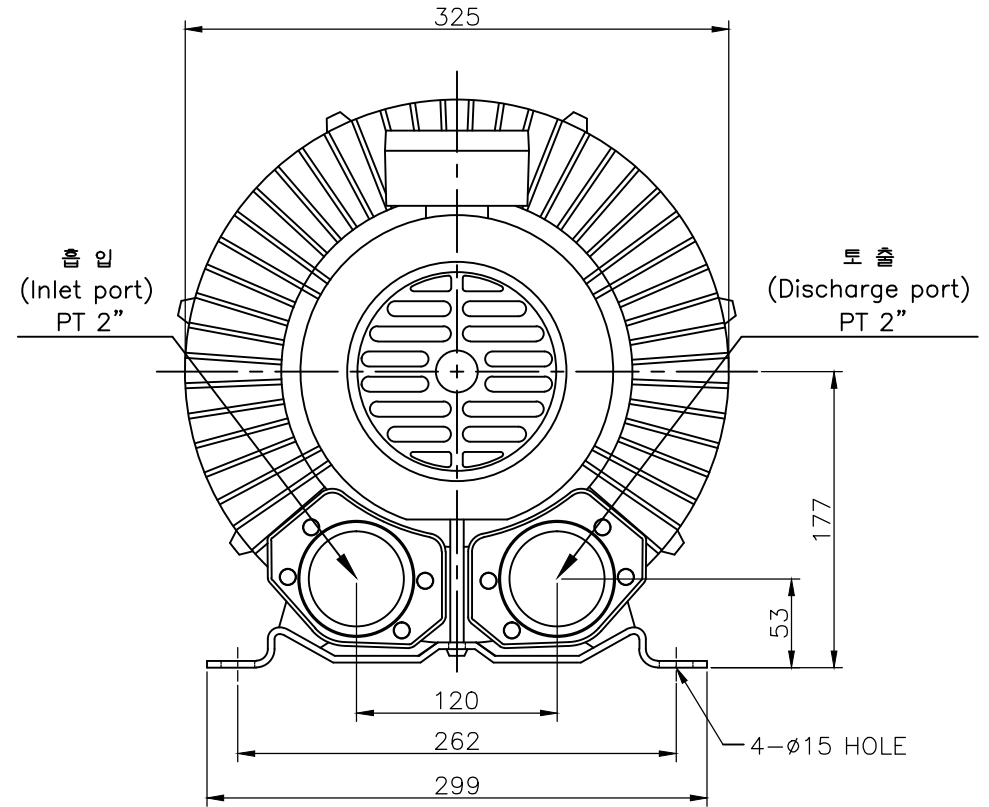
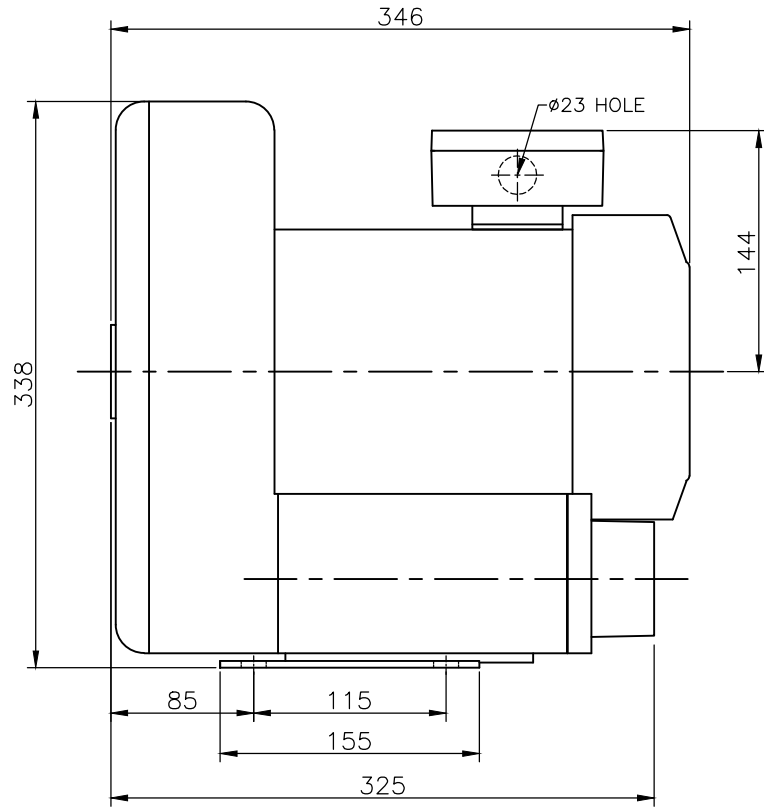

△		00					
No.	Revision			Date	Draw	Check	Appr.
형식 TYPE	HRB-400		도명 TITLE	OUTWARD DWG.			
DRAWN	DESIGN	CHECKED	APPROVED	3RD ANGLE	SCALE:1/1	UNIT:mm	
B.S.Kim				SIZE	3ø 2P 2.55Kw		
13.04.22							
黃海電機 HWANG HAE ELECTRIC				도번 DWG. No	BOD00035		△