

NOTE 1)

No.	PART NAME	MATERIAL	Qt'y	SIZE	REMARK
01					

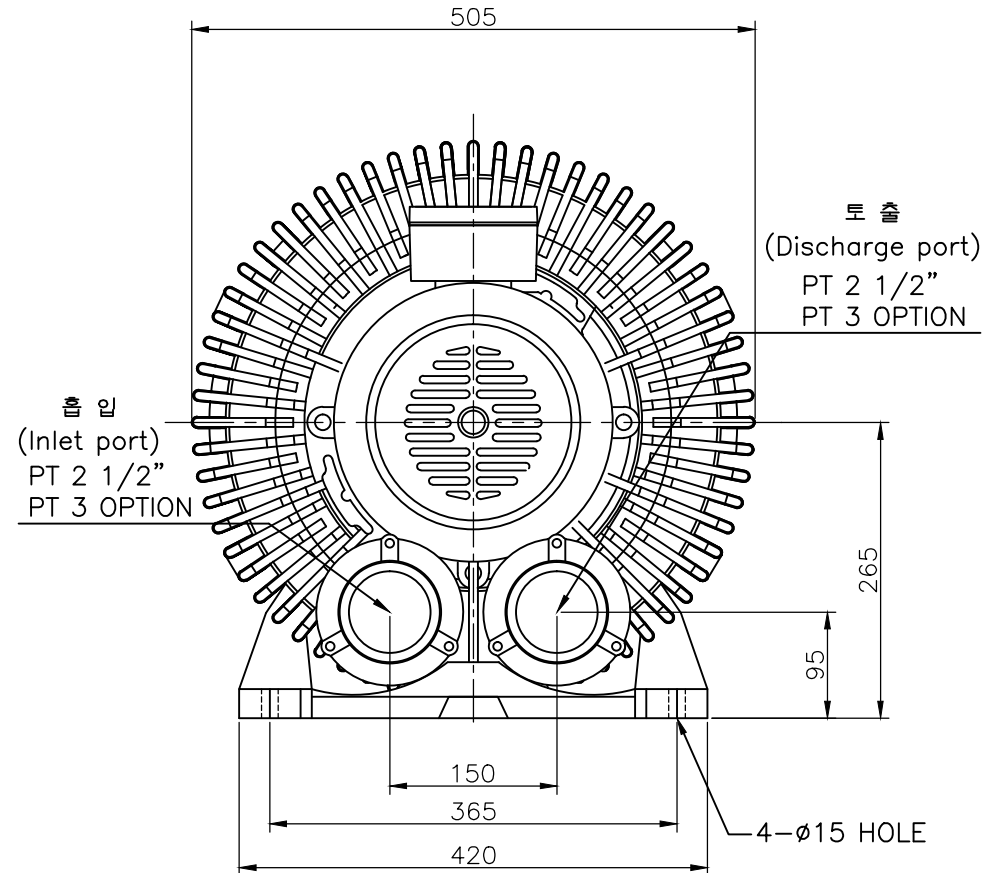
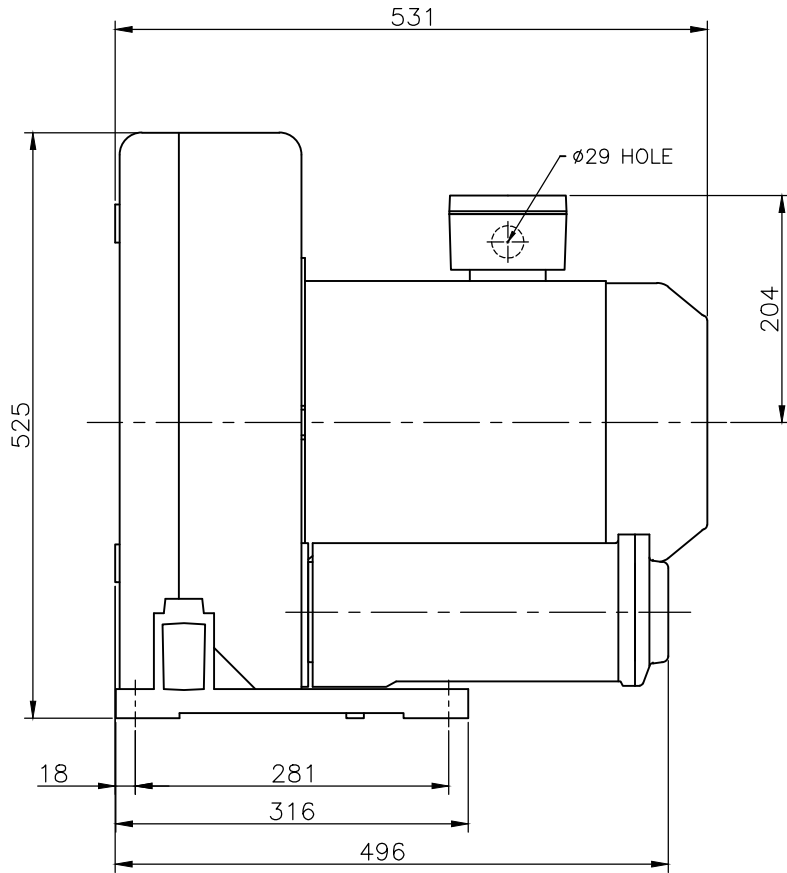

No.	Revision			Date	Draw	Check	Appr.
형식 TYPE	HRB-900		도명 TITLE	OUTWARD DWG.			
DRAWN	DESIGN	CHECKED	APPROVED	3RD ANGLE	SCALE:1/1	UNIT:mm	
B.S.Kim				SIZE	3Ø 2P 8.6Kw		
13.04.22				도번 DWG. No	BOD00056		△
黃海電機 HWANG HAE ELECTRIC							