

DAEHAN SENSOR



Digital Liquid Indicate
with level controller

DLC – Series
Level Indicator with Relay Output

Product Name
DLC – 4U – M – 2W



ISO 9001 인증업체

Table of Contents

1. Introduction	3
2. Specification	3
3. Dimensiosns	4
4. Wiring Connection	5
5. Display Operation	7
6. Check Point Before A/S	9

SPECIFICATIONS

Introduction

This DLC-4U-M-2W Series Level Controller gets signal from each point of the sensor installed in the tank and displays the level of the liquid in the tank as points.

Using a converter for 2-wire transmission, this changes contact signal to current.

LED display enables you to read the current status correctly and easily.

This is designed to control one alarm and one of control which activates the connected pump.

It is designed to control two pumps and able to control sequentially or alternatively.

Sequential control means that pump 1 always operates before pump 2.

Alternative control means that pump 1 and pump 2 operates in turn which extends life of the pumps.

This product is set for sequential control mode.

Specification

- ▶ Power Supply AC110V / 220V \pm 10%, 50/60Hz
- ▶ Operating Temperature 0°C ~ 60°C
- ▶ Dimensions 87mm (Wide) x 155mm (High) x 69mm (Deep)
- ▶ Material Polycarbonate & A,B,S
- ▶ Max. Switching Current Capacitor 1250VA, 150W
- ▶ Max. Switching Voltage 250VDC, 30VDC
- ▶ Max. Switching Current 5A

Dimensions

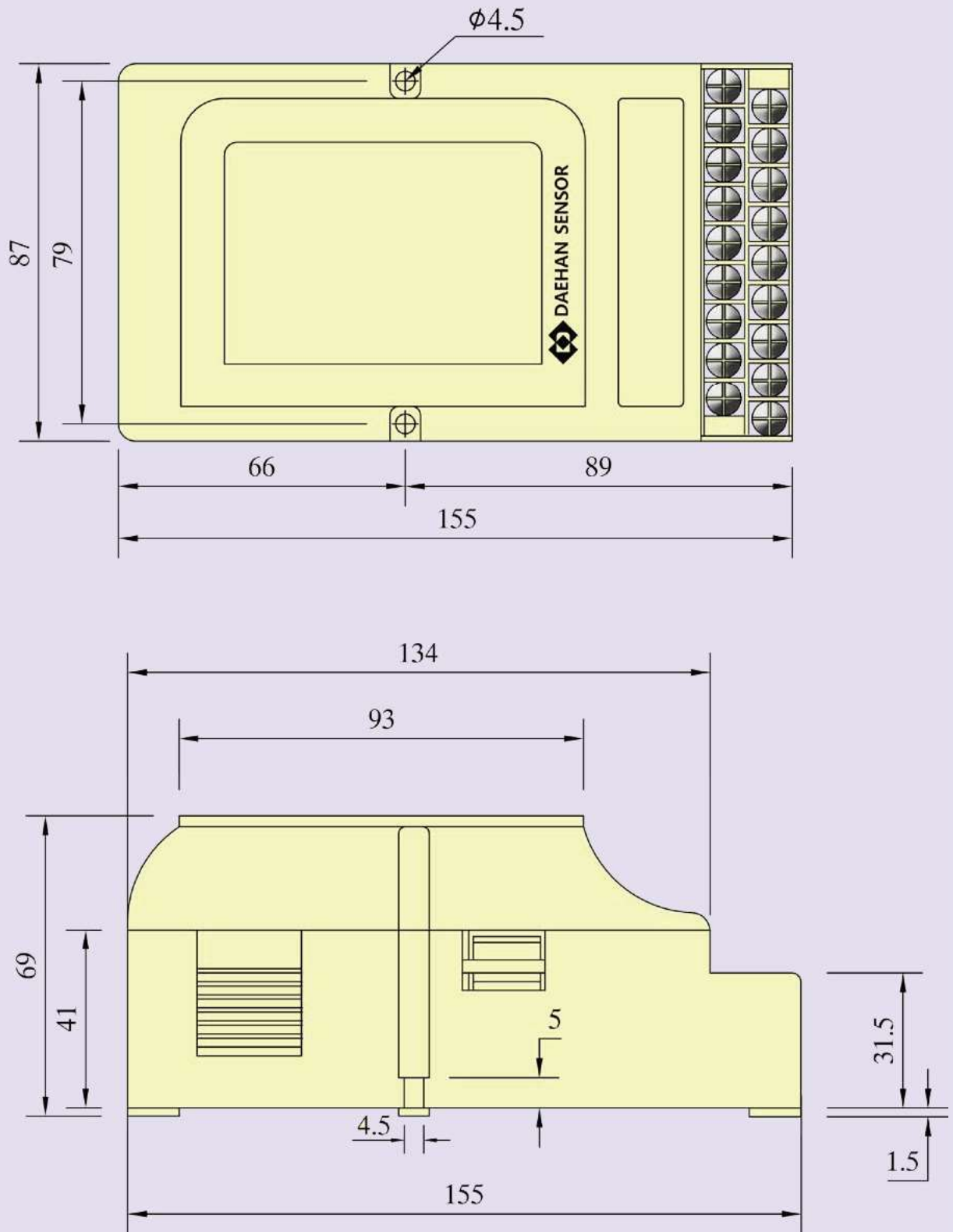

Wiring Connection

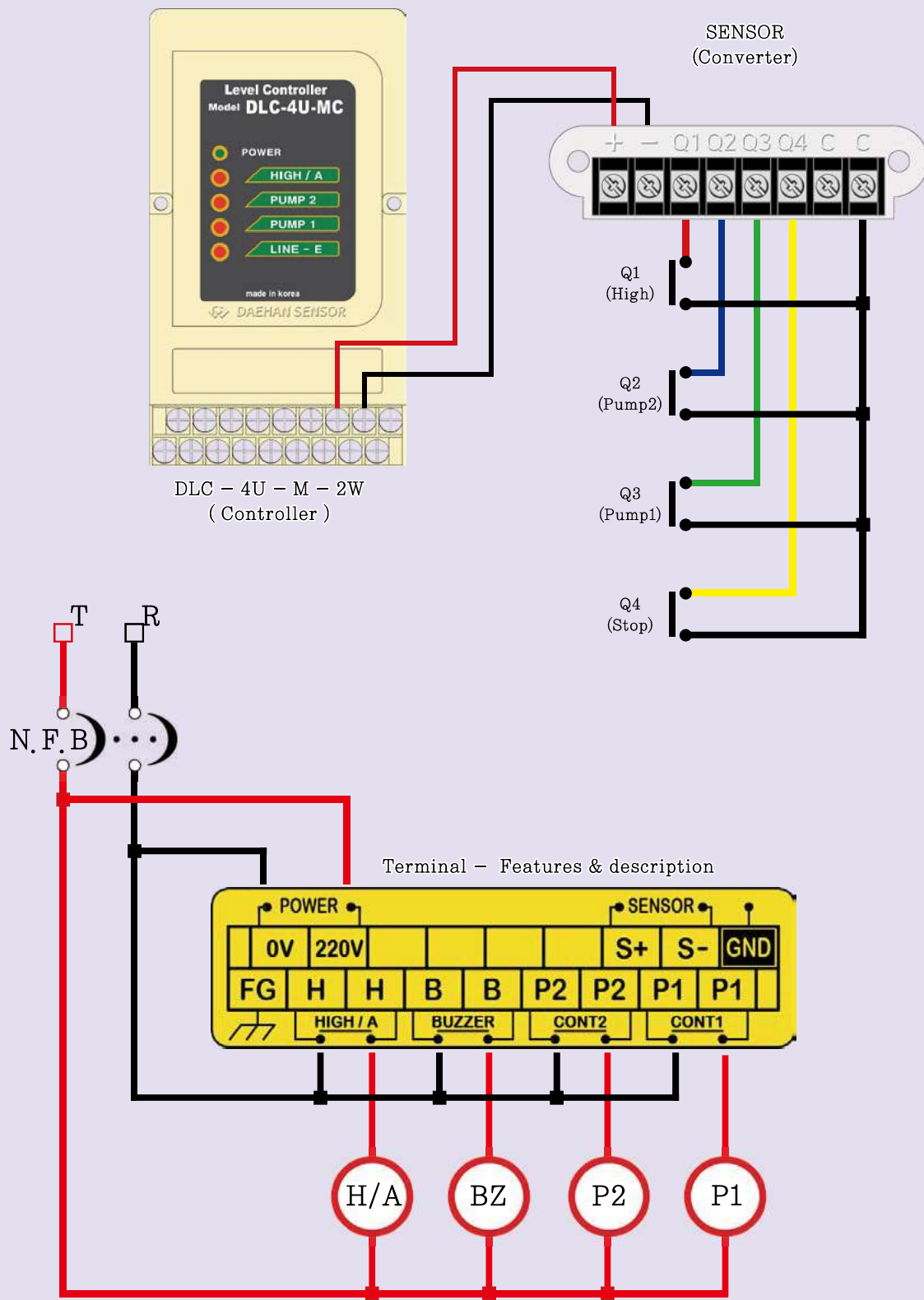

Wiring Connection

sequentially / alternatively Selection

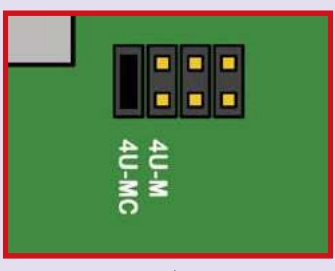
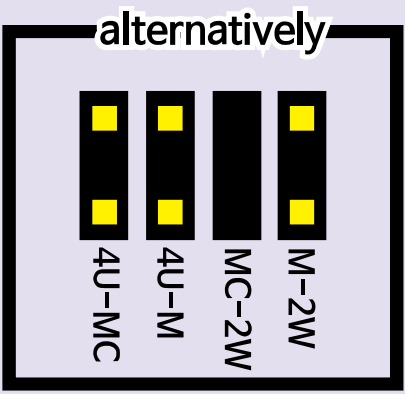
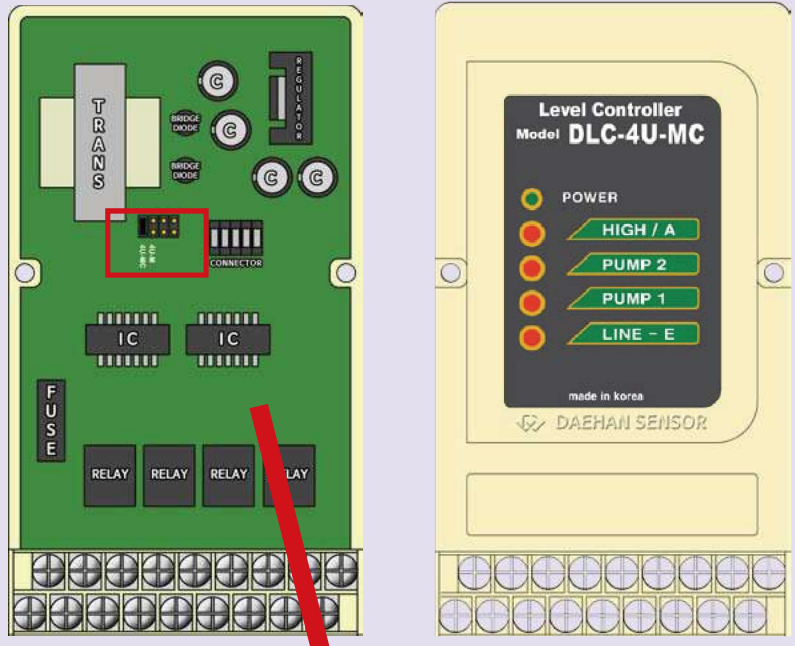

seq. / alt.
Selection



Display Operation

1. Low Level Display

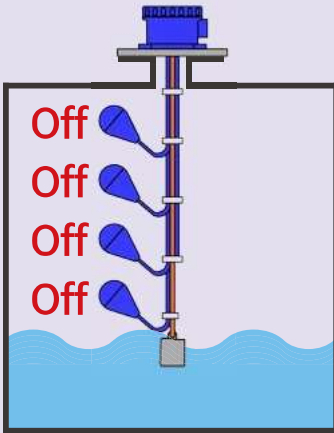

When the liquid level goes up to reach the STOP point, the All indicator turns on. At the same time, the All contact signal is not out and deactivates the connected pump.

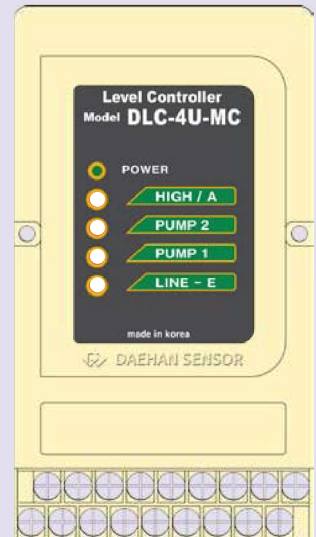

2. High Level Display

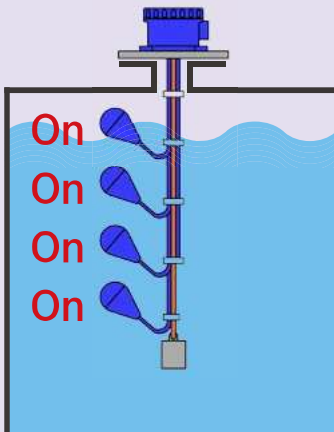

When the liquid level goes Up to reach the HIGH/A point, the HIGH/A & PUMP1 & PUMP2 indicator turns on. At the same time, the HIGH/A & PUMP1 & PUMP2 contact signal activates the connected buzzer and purmp.

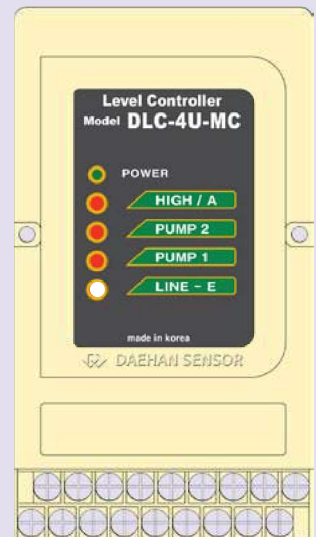

Display Operation

1. Pump "1" – Control "On" Level Display

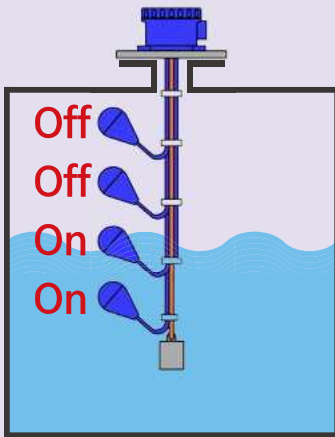

When the liquid level goes Down to reach the START1 point, the Pump1 or Pump2 indicator turns on.
At the same time, the Pump1 or Pump2 contact signal activates the connected pump.



2. Pump "2" – Control "On" Level Display

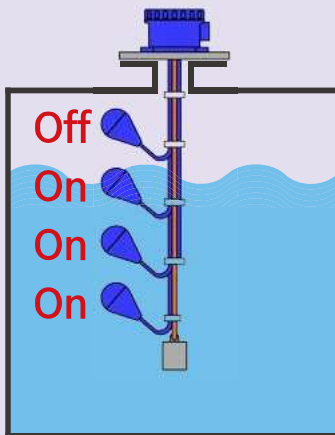

When the liquid level goes Down to reach the START2 point, the Pump1 & Pump2 indicator turns on.
At the same time, the Pump1 & Pump2 contact signal activates the connected pump.

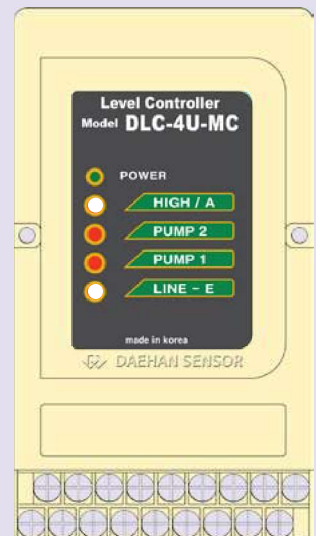

Check & A/S

If you find any abnormal system during operation, please try to check below points.

1. Is the power connected to AC110V or AC220V correctly?
2. Is the wiring to the sensor made correctly?
3. Is the contact with the relay built up through correct sequence?
4. Is the current input from the sensor correct?
5. Is there any malfunction around the unit?

If the trouble still exists, please kindly contact below.

* Installation and operation manual is subject to change without prior notice for quality improvement.

Head Office
94-2, Yongdap-dong, Seongdong-gu, Seoul, Korea

R&D Office
2-71, Jeonong-dong, Dongdaemun-gu, Seoul, Korea

Tel : 02-2213-9888(代) Fax : 02-2245-3482
e.mail : master@dh34.com Domain : www.dh34.com