

DAEHAN SENSOR



Digital Liquid Indicate
with level controller

DLC – Series
Level Indicator with Relay Output

Product Name
DLC – 3M



ISO 9001 인증업체

Table of Contents

1. Introduction	3
2. Specification	3
3. Dimensiosns	4
4. Wiring Connection	5
5. Display Operation	7
6. Check Point Before A/S	10

SPECIFICATIONS

Introduction

This DLC-3M Series Level Controller gets signal from each point of the sensor installed in the tank and displays the level of the liquid in the tank as points.

It is very much easy to install and do the wiring.

The convertor of DQ-5S is used to transmit via 2-wire type, which converts contact signal of ball sensor to current.

It is easy to read the current status of ball sensor since it has LED.

It is designed to control three pumps sequentially or alternatively and two alarms.

Sequential control means that pump 1 always operates before pump 2.

Alternative control means that pump 1 and pump 2 operates in turn which extends life of the pumps.

DLC-3M product is set for alternative control mode of drainage.

Specification

- ▶ Power Supply AC110V / 220V \pm 10%, 50/60Hz
- ▶ Operating Temperature 0°C ~ 60°C
- ▶ Dimensions 87mm (Wide) x 155mm (High) x 69mm (Deep)
- ▶ Material Polycarbonate & A.B.S
- ▶ Max. Switching Current Capacitor 1250VA, 150W
- ▶ Max. Switching Voltage 250VDC, 30VDC
- ▶ Max. Switching Current 5A

Dimensions

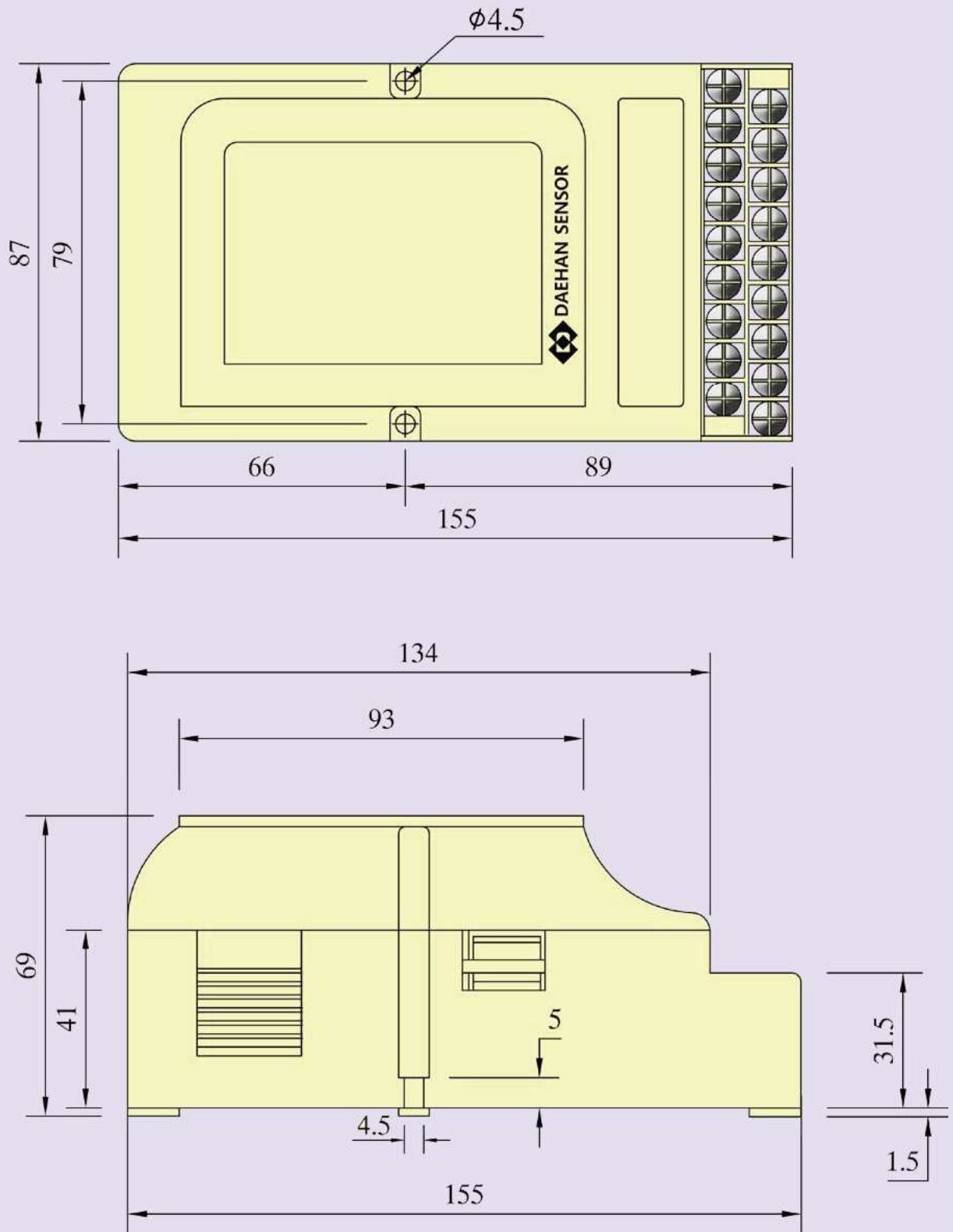

Wiring Connection

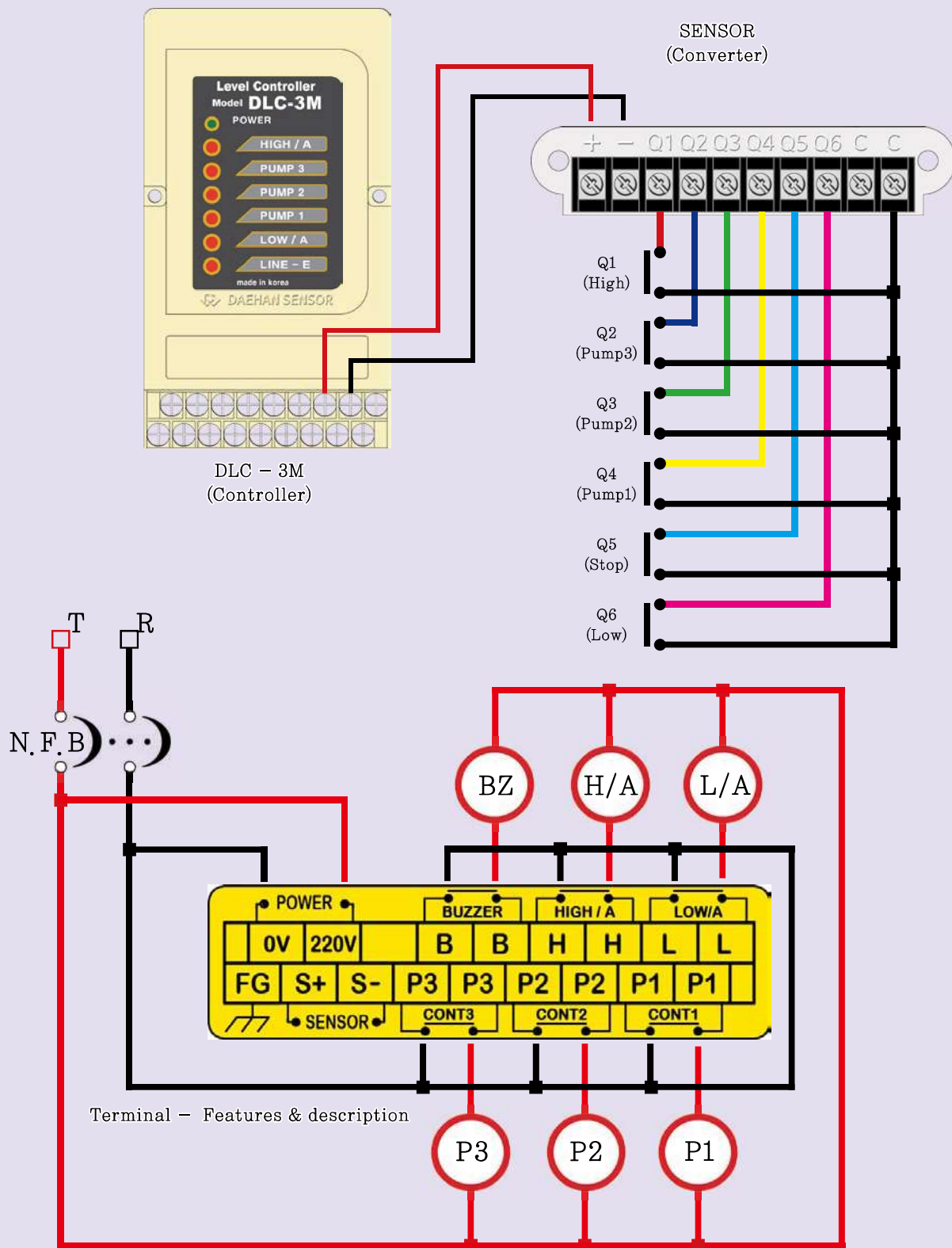

Wiring Connection

sequentially / alternatively Selection
Supply / Drain Selection

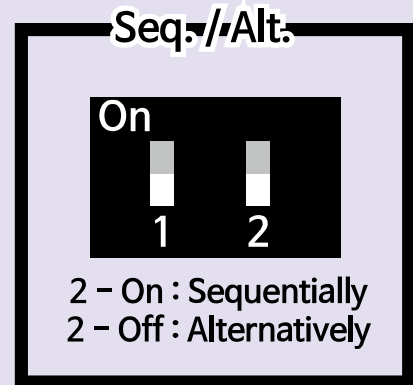
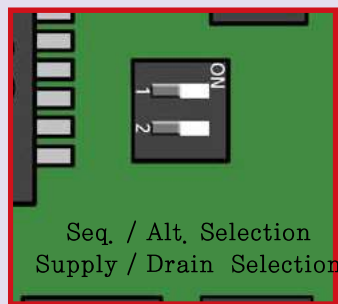
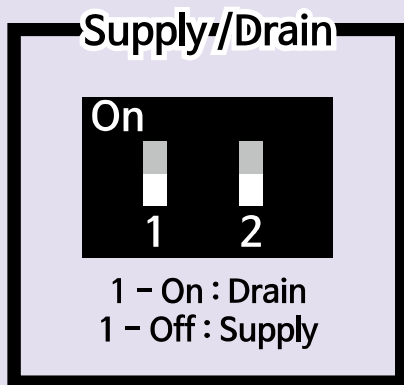
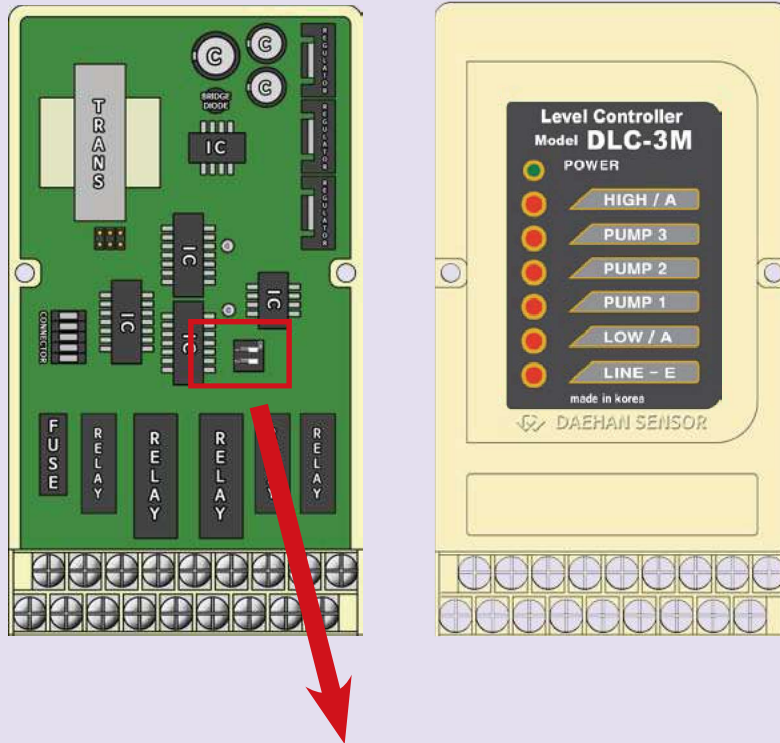

Display Operation

1. Low Level Display

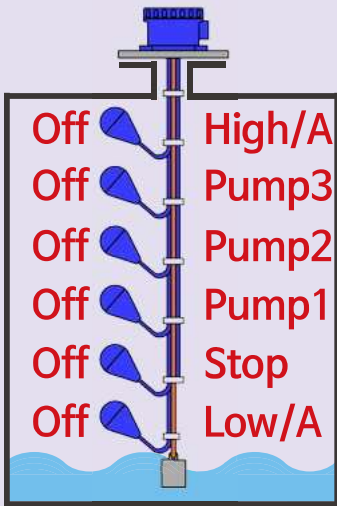

When the liquid level goes Down to reach the LOW/A point, the LOW/A indicator turns on. At the same time, the LOW/A contact signal activates the connected buzzer and pump.

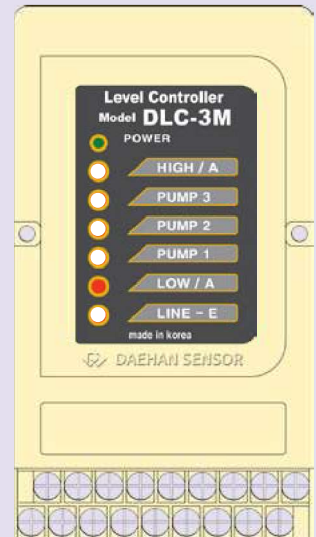

2. High Level Display

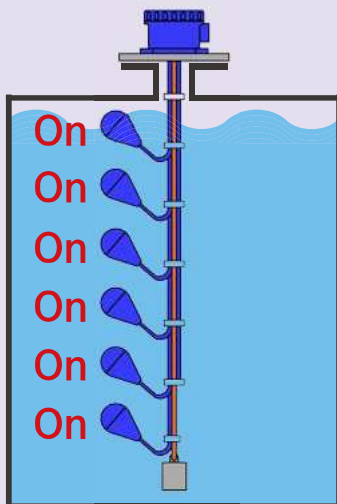

When the liquid level goes Up to reach the HIGH/A point, the HIGH/A indicator turns on. At the same time, the HIGH/A contact signal activates the connected buzzer and pump.

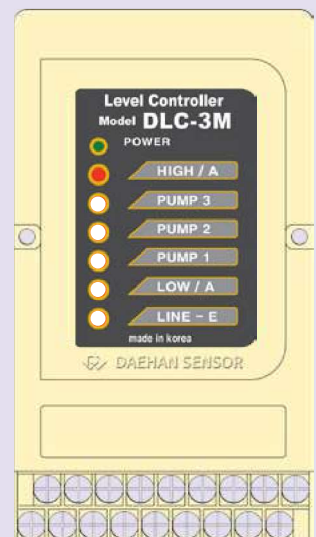

Display Operation

1. Supply Control "On" Level Display

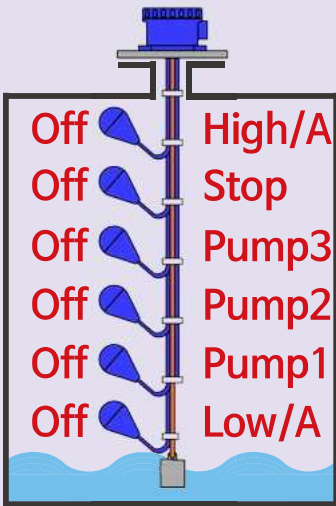

When the liquid level goes Down to reach the START point, the Control indicator turns on. At the same time, the Control contact signal activates the connected pump.



2. Supply Control "Off" Level Display

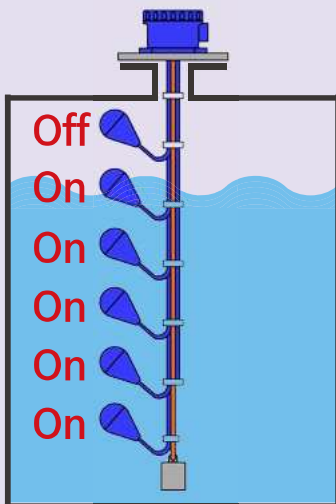

When the liquid level goes up to reach the STOP point, the Control indicator turns off. At the same time, the CONTROL contact signal is not out and deactivates the connected pump.

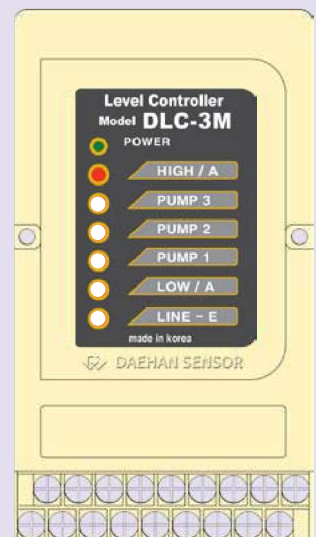

Display Operation

1. Drain Control "On" Level Display

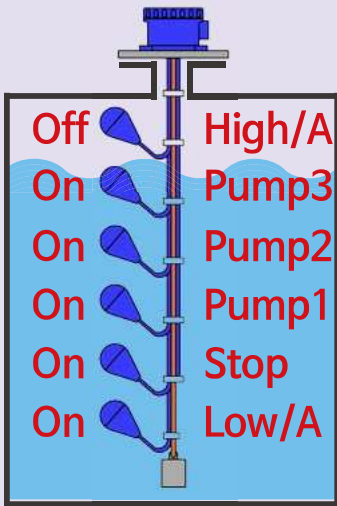

When the liquid level goes Up to reach the START point, the Control indicator turns on. At the same time, the Control contact signal activates the connected pump.

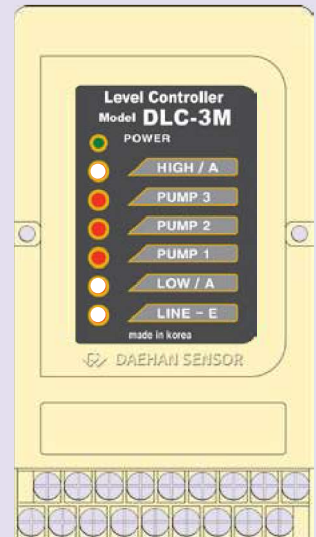

2. Drain Control "Off" Level Display

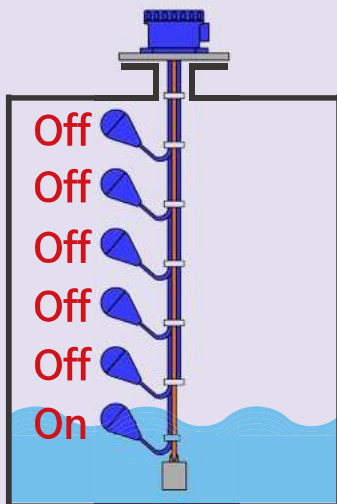

When the liquid level goes Down to reach the STOP point, the Control indicator turns off. At the same time, the CONTROL contact signal is not out and deactivates the connected pump.

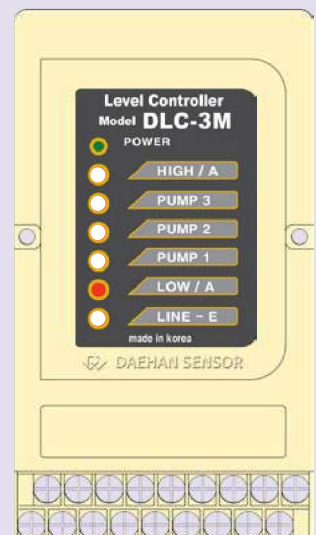

Check & A/S

If you find any abnormal system during operation, please try to check below points.

1. Is the power connected to AC110V or AC220V correctly?
2. Is the wiring to the sensor made correctly?
3. Is the contact with the relay built up through correct sequence?
4. Is the current input from the sensor correct?
5. Is there any malfunction around the unit?

If the trouble still exists, please kindly contact below.

* Installation and operation manual is subject to change without prior notice for quality improvement.

Head Office
94-2, Yongdap-dong, Seongdong-gu, Seoul, Korea

R&D Office
2-71, Jeonong-dong, Dongdaemun-gu, Seoul, Korea

Tel : 02-2213-9888(代) Fax : 02-2245-3482
e.mail : master@dh34.com Domain : www.dh34.com