

since1992

LED LIGHTING FIXTURES & EQUIPMENTS

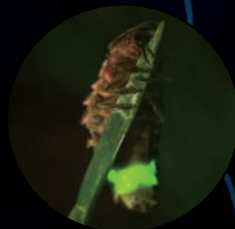



energy

electricity

eco-friendly

Leading Enterprise for
Energy Saving Innovation



— Group —

- KUKDONG ELECOM
- KESKOM CO.,LTD.
- KUKDONG ELECOM - dalian
- KUKDONG TECHWAY - dalian
- KUKDONG C&SS - dalian

"GLOBAL KOREA, GLOBAL KUKDONG"

ISO 9001



ISO 14001



OHSAS 18001



ISES



The Brief History of Company

- 2013
 - KukDong has been registrating to World first rank Products/
 - KukDong had invented and developed as EM-RCS(Energy Monitoring-Reefer Container Socket).
 - kukdong got recorded as supplied to Dubai Port World as first delivery.

- 2012
 - Selected one of the exporting company of 100 companies in Domestic for "Promoting Program for Global Strong Small-Mid sized Business" supported by Government
 - Achieved "OHSAS 18001 Certificate" from BVQI-Korea Ceremony as anniversary of 20 years from foundation. In comodore Hotel n Busan had invented new layer type MCT(Multi Core Transit). had achieved for Accident free worksday for 1,000days.

- 2011
 - Participated in "EUROPORT 2011 in Turkey" "SEA ASIA 2011 in Singapore" " BARISHIP 2011 in Japan" "MARINTEC China" as exhibitor

- 2010
 - Participated in "SMM 2010 Exhibition"
 - Participated in "SEAJAPAN 2010" & "VIETSHIP 2010"

- 2009
 - Won "The 2009 Great Prize of Small & Medium Enterprises in Busan" and Received certificate as "A Superior Enterpriser" from Busan city
 - Opened the Yeosu branch office in Jeollanamdo

- 2008
 - 1st place award, 2008 Korea Innovation Management by Newspeople
 - Established 3rd factory
 - Participated in "VIETSHIP 2008"
 - Participated in "2008 South-east Asia Market Developing Association"

- 2007
 - Appointed as the leading company for strategic industry from Busan city
 - Accepted to supply our lighting without the inspection from Hyundai Heavy Industries.
 - Be entrusted our lighting quality by our inspection from DSME
 - Contracted "OFF SHORE project 6 Sets" from LABROY in Singapore working with COOPER Crouse-Hinds
 - Acquired the ISO/KSA 14001 Quality System from Bureau Veritas
 - Received USD 1 million export trophy" from the president and a letter of commendation from Prime Minister at the 44th Trade Day

- 2006
 - Established 2nd Factory
 - Achieved the Certificate of Flame-Proof Lighting for Marine from Korea Marine Equipment Research Institute
 - Contracted "Sea Drill Project" from DAEWOO Shipbuilding working with COOPER Crouse-Hinds.
 - Kukdong Elecom Factory advanced into Dalian, China
 - Opened the branch office in Gwaebup-dong, Busan

- 2005
 - Completed "1st step innovation consulting"
 - Selected as the innovated company called "INNO-BIZ" by Korean Government

- 2004
 - Selected as Superiority Lighting Company by Korea Illumination Research Institute(KIRI)

- 2003
 - Acquired certificate for KS (Korean Standard) from Korea Standard Association (No.03-4419)

- 2002
 - Acquired certificate for ISO 9001/2000 Quality from Burean Veritas
 - Received "USD 5 million export trophy" from president and a letter of commendation from Prime Minister at the 39th Trade Day

- 2001
 - Became a member of ISES for the worldwide after service network
 - Selected as a promoted company by Korea Technology Credit Fundamental Foundation (TECF)
 - Selected as a Family Company by Korea Small and Medium Industry Bank
 - The First Turnover from Shipbuilding Field at the STX Shipbuilding Company

- 2000
 - Took over the lighting manufacturer Dong-Sung Electrical Co., Ltd.
 - Changed the company name "Kukdong Elecom Co., Ltd."
 - Contracted a project for the school and industry cooperation with Ho-seo University
 - Joined as a member of KOMEA (Korea Marine Equipment Association)

- 1992
 - Established in the name of "Kukdong Cable Sales Co., Ltd."

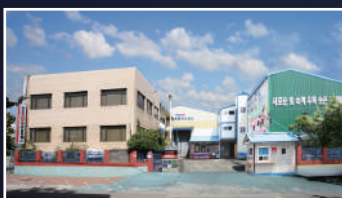

Head office & No. 1 Factory



No. 2 Factory



No. 3 Factory



No. 4 Factory

Major Production Items

- Marine Lighting Fixtures
- Offshore Lighting Fixtures
- Naval Lighting Fixtures
- LED Lighting Fixtures
- Ex-proof Lighting Fixtures (with ATEX Certificate)
- Search Light for Low Temperature Operation (-45°C)
- RCS (Reefer Container Socket)
- MCT (Multi Cable Transit)
- Night Vision System
- Lighting Fixtures for Industrial Use



Certificate

- LED WORKING LAMP WITH HEAT SINK OF POLYGONAL STRUCTURE
- FLUORESCENT LED LIGHTING LAMP APPARATUS USING SHIP
- THE ELECTRIC SOCKET FOR CONTAINER
- Marine LED Navigation lights
- Multi Cable Transit for electromagnetic interference shielding end packing
- Cable penetration sealing system for shielding electromagnetic wave
- Multi cable transit packing system for shielding electromagnetic wave
- Insert blocks for shielding electromagnetic wave
- CEILING ESTABLISHMENT DEVICE OF LAMP CASE
- AN ELECTRIC WIRE ESTABLISHMENT DEVICE OF TOWER LAMP
- HINGE DEVICE OF A FLUORESCENT PC COVER
- CEILING ESTABLISHMENT DEVICE OF LAMP CASE
- ELECTRICITY OFF DEVICE OF BREAKER SWITCH
- LATCH FIXING DEVICE OF A FLUORESCENT LAMP
- LATCH DEVICE OF A FLUORESCENT LAMP
- SEARCH LIGHT
- LED WORKING LAMP WITH REFLECTOR
- HOLD INSIDE WORK LED ILLUMINATING DEVICE OF CAR CARRIER
- MULTI LAYER INSERT BLOCK SHEET FOR MULTI CABLE TRANSIT USING THERMOPLASTIC VULCANIZATE

Organization

Engineering Team
Designing Team



Planning Team
Management Team



KUKDONG



Domestic Sales Team
Overseas Sales Team



Products Managing Team
Manufacturing Team

Major clients

- Domestic Market
- HYUNDAI HEAVY INDUSTRIES
- HYUNDAI SAMHO HEAVY INDUSTRIES
- HYUNDAI MIPO DOCKYARD
- SAMSUNG HEAVY INDUSTRIES
- DAEWOO SHIPBUILDING & MARINE ENGINEERING
- HYUNDAI SAMHO HEAVY INDUSTRIES
- STX OFFSHORE & SHIPBUILDING
- HANJIN HEAVY INDUSTRIES
- SUNGDONG SHIPYARD
- SLS / SPP SHIPYARD

Overseas Market

JAPAN

MITSUBISHI HEAVY INDUSTRIES
USC GROUP / TSU, ARIAKE, MAIZURU S.Y
SHINKURUSHIMA / IHI / SHINKOCHI/KYOKUYO

CHINA

SINO-PACIFIC GROUP/ DAYANG, ZHEJIANG
JIANGNAN/ CHENGXI/ NEW TIMES/ CHANGBO
YANGZIJIANG / TSUJI S.Y / ZHEJIANG CHENYE
SHANGHAI / COSCO ZHOUSHAN / SANFU S.Y
JIANGXIN / FUJIAN DONGNAN S.Y
BOHAI / COSCO DALIAN / XINGANG S.Y

VIETNAM

VINA-SHIN GROUP/ NAMTRIEU / HALONG
BACH DANG / PHARUNG / DUNG QUAT S.Y
BENKIEN S.Y / 189 S.Y

TURKEY

DEGUSAN / YARDIMCHI / SOLI /
SEFINE / SAHIN / FILIZ

SINGAPORE / INDIA / IRAN / MALAYSIA

KUKDONG ELECOM's LED technology more shines it self in an extremely cold situation.

It has been completed through world-best technology beyond global standards. Have an opportunity to experience the world-class LED technology that functions well even at 45°C below zero.



Korea Marine Equipment Research Institute Certificate of Test

Test condition of cold test

Test chamber conditions	
Temperature	(- 45 ± 3) °C



Sample set-up for cold test



Light meter

It is different opinions for innovation that KUKDONG ELECOM has LED.

The module-type Quick Changing LED system of KUKDONG ELECOM is proud of being excellent in cost reduction, changeability and convenience.

Although a ship has to stay at sea for a long period, it is not inconvenient because it's LED makes module exchange between products possible and thus it is not necessary to change prepared spare parts.

KUKDONG ELECOM is ready and willing to lighten at any place in any easy manner.



Contents

LED LIGHTING FIXTURE FOR MARINE USE	9
LIGHTING FIXTURE FOR ON DECK	24
LIGHTING FIXTURE FOR EXPLOSION-PROOF	35
WIRING DEVICE FOR LIGHTING FIXTURES	42
LED LIGHTING FIXTURE FOR NAVAL VESSEL	54
LED LIGHTING FIXTURE FOR ON-SHORE	67
REEFER CONTAINER SOCKETS & MONITORING SYSTEM	75



**LED
LIGHTING FIXTURE
FOR MARINE USE**

LED LIGHTING FIXTURE FOR MARINE USE

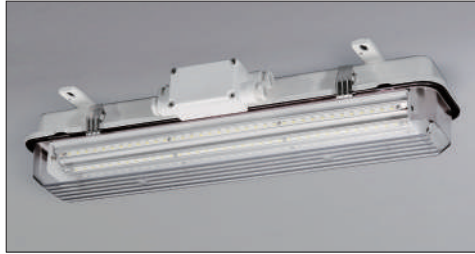
**LES*W-S****LED SURFACE CEILING LIGHT IP56**

Engine room, Cargo hold, laundry, store
 Body : Electro zinc galvanized steel sheet
 Diffuser : Milky / clear polycarbonate
 LED : 0.2W LED Package (Aluminium round heating plate)
 Cable entry : Terminal box, 4-Cable glands

Model no.	Capacity	L(mm)	W(mm)	H(mm)	Weight(kg)	Remarks
LES151W-S	15W	715	223	133	4.70	FL18W x 1
LES152W-S	30W	715	223	133	4.73	FL18W x 2
LES291W-S	29W	1350	223	133	7.03	FL36W x 1
LES292W-S	58W	1350	223	133	7.06	FL36W x 2

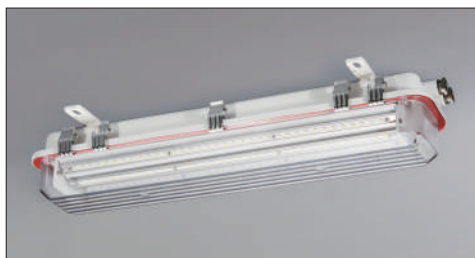
**LES*W-U****LED SURFACE CEILING LIGHT IP67**

Outside passage way, cargo holder, workshop
 Body : Stainless steel sheet
 Diffuser : Milky / clear polycarbonate
 LED : 0.2W LED Package (Aluminum round heating plate)
 Cable entry : 2-Cable glands

Model no.	Capacity	L(mm)	W(mm)	H(mm)	Weight(kg)	Remarks
LES151W-U	15W	715	223	133	4.55	FL18W x 1
LES152W-U	30W	715	223	133	4.58	FL18W x 2
LES291W-U	29W	1350	223	133	6.83	FL36W x 1
LES292W-U	58W	1350	223	133	6.86	FL36W x 2

**LES*S****LED THIN SURFACE CEILING LIGHT IP44**

Galley, laundry, pantry and store
 Body : Stainless steel sheet
 Diffuser : Milky / clear polycarbonate
 LED : 0.2W LED Package
 Cable entry : 4-Cable inlet hole

Model no.	Capacity	L(mm)	W(mm)	H(mm)	Weight(kg)	Remarks
LES151S	15W	711	223	82.4	4.22	FL18W x 1
LES152S	30W	711	223	82.4	4.25	FL18W x 2
LES291S	29W	1321	223	82.4	6.53	FL36W x 1
LES292S	58W	1321	223	82.4	6.56	FL36W x 2

**LES*N****LED SURFACE CEILING LIGHT IP20**

Accommodation areas, inside passage ways
 Body : Electro zinc galvanized steel sheet
 Diffuser : Milky polycarbonate
 LED : 0.2W LED Package
 Cable entry : 1-Cable inlet hole

Model no.	Capacity	L(mm)	W(mm)	H(mm)	Weight(kg)	Remarks
LES151N	15W	762	216	63	3.90	FL18W x 1
LES152N	30W	762	216	63	3.94	FL18W x 2
LES291N	29W	1250	216	63	7.20	FL36W x 1
LES292N	58W	1250	216	63	7.24	FL36W x 2

LED LIGHTING FIXTURE FOR MARINE USE

**LEF*N****LED FLUSH CEILING LIGHT IP20**

Accommodation areas, inside passage ways
 Body : Electro zinc galvanized steel sheet
 Diffuser : Milky polycarbonate
 LED : 0.2W LED Package
 Cable entry : 6-Snap bushing

Model no.	Capacity	L(mm)	W(mm)	H(mm)	Weight(kg)	Remarks
LEF151N	15W	684	181	181	4.21	FL18W x 1
LEF152N	30W	684	181	181	4.24	FL18W x 2
LEF291N	29W	1294	181	181	7.23	FL36W x 1
LEF292N	58W	1294	181	181	7.26	FL36W x 2

**LEF*S****LED THIN FLUSH CEILING LIGHT IP44**

Galley, laundry, pantry
 Body : Electro zinc galvanized steel sheet
 Diffuser : Milky polycarbonate(Aluminium frame)
 LED : 0.2W LED Package
 Cable entry : 4-Cable glands

Model no.	Capacity	L(mm)	W(mm)	H(mm)	Weight(kg)	Remarks
LEF151S	15W	677	275	111	7.60	FL18W x 1
LEF152S	30W	677	275	111	7.63	FL18W x 2
LEF291S	29W	1270	275	111	12.70	FL36W x 1
LEF292S	58W	1270	275	111	12.73	FL36W x 2

**LEW*N****LED NO-GAP FLUSH CEILING LIGHT IP44**

B-0, B-15

Accommodation areas, saloon, dining room, inside passage ways
 Body : Electro zinc galvanized steel sheet
 Diffuser : Milky polycarbonate(Aluminium frame)
 B15 Insulation : AL Foil (Hi-wool)
 LED : 0.2W LED Package
 Cable entry : 6-Snap bushings

Model no.	Capacity	L(mm)	W(mm)	H(mm)	Weight(kg)	Remarks
LEW152N	30W	677	275	111	8.5	FL18W x 2
LEW292N	58W	1287	275	111	15.6	FL36W x 2

**LEC*N****LED DAMPA FLUSH CEILING IP20/IP44**

B-0, B-15

Accommodation areas, saloon, dining room
 Body : Electro zinc galvanized steel sheet
 Diffuser : Milky polycarbonate
 B15 Insulation : AL Foil (Hi-wool)
 LED : 0.2W LED Package
 Cable entry : 6-Snap bushings

Model no.	Capacity	L(mm)	W(mm)	H(mm)	Weight(kg)	Remarks
LEC152N	30W	645	275	84.2	5.75	FL18W x 2
LEC292N	58W	1270	275	84.2	8.80	FL36W x 2

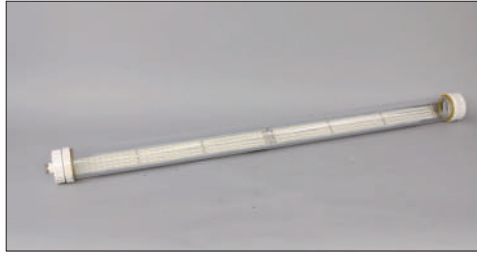
**LEY*W****LED CYLINDER CEILING LIGHT IP67**

Outside passage way, deck.
 Body : Cast aluminium / PBT
 Diffuser : Clear polycarbonate
 LED : 0.2W LED Package
 Cable entry : 1-Cable gland

Model no.	Capacity	L(mm)	W(mm)	H(mm)	Weight(kg)	Remarks
LEY151W	15W	1080	92	890	3.70	FL18W x 1
LEY291W	29W	1690	92	1500	5.00	FL36W x 2

**LEP*N****LED CONER LIGHT IP20**

Accommodation areas, inside passage ways, coner
 Body : Electro zinc galvanized steel sheet
 Diffuser : Milky polycarbonate
 LED : 0.2W LED Package
 Cable entry : 4-Snap bushings

Model no.	Capacity	L(mm)	W(mm)	H(mm)	Weight(kg)	Remarks
LEP151N	15W	640	160	65	3.77	FL18W x 1
LEP291N	29W	1250	160	65	5.25	FL36W x 2

**LEB(D)*SN****LED BERTH/DESK LIGHT IP20**

Accommodation areas, berth & desk wall
 Body : Aluminium pressing out bar
 Diffuser : Milky polycarbonate
 LED : 0.2W LED Package
 Cable entry : 1-Cable inlet hole (30mm dia)

Model no.	Capacity	L(mm)	W(mm)	H(mm)	Weight(kg)	Remarks
LEB12SN	12W	524	70	113	1.80	FL15W w/switch
LEB15SN	15W	677	70	113	2.00	FL18W w/switch
LED12SN	12W	524	70	113	1.80	FL15W w/switch
LED15SN	15W	677	70	113	2.00	FL18W w/switch

**LEM*SS(IS)****LED MIRROR LIGHT IP44**

With switch, Universal socket & ISO TR.

Accommodation areas, toilet, shower room
 Body : Aluminium pressing out bar
 Diffuser : Milky polycarbonate
 LED : 0.2W LED Package
 Cable entry : 2-Cable grands (PG16)

Model no.	Capacity	L(mm)	W(mm)	H(mm)	Weight(kg)	Remarks
LEM05SS	5W	392	70	113	1.30	
LEM12IS	12W	542	70	113	2.30	ISO.TR.
LEM15IS	15W	677	70	113	2.00	ISO.TR.

- With ISO. TR. & uni. Socket

LED LIGHTING FIXTURE FOR MARINE USE

**LEPH-P****LED PENDANT LIGHT IP56**

Engine room, workshop, stores, cargo hold, toilet
 Body : PBT (Poly Butylene Terephthalate) Guard : Cast brass or clear PC
 Globe : Clear hard glass (S90)
 LED : 3~8W Bulb type bulb
 Cable entry : 2 Cable glands

Model no.	Capacity	L(mm)	W(mm)	H(mm)	Weight(kg)	Remarks
LEPH-03WG-P	3W	114	114	228	0.96	E26/27
LEPH-05WG-P	5W	114	114	228	0.96	E26/27
LEPH-08WG-P	8W	114	114	228	0.96	E26/27

- Optional : with Stainless steel Screen (LEPH-*WU-P), with Hanging hook (LEPH-WH-P)

**LEKH-P****LED BULKHEAD LIGHT, 4HOLE IP56**

Engine room, workshop, stores, cargo hold, outside passage ways
 Body : PBT (Poly Butylene Terephthalate) Guard : Cast brass or clear PC
 Globe : Clear hard glass (S90)
 LED : 3~8W Bulb type
 Cable entry : Flange seat (50A pipe)

Model no.	Capacity	L(mm)	W(mm)	H(mm)	Weight(kg)	Remarks
LEKH-03WG-P	3W	155	144	267	1.24	E26/27
LEKH-05WG-P	5W	155	144	267	1.24	E26/27
LEKH-08WG-P	8W	155	144	267	1.24	E26/27

- Optional : with Stainless steel Screen (LEKH-*WU-P)

**LEKHN-P****LED BULKHEAD LIGHT, 3HOLE IP56**

(NEW JIS TYPE)

Engine room, workshop, stores, holds, outside passage ways
 Body : PBT (Poly Butylene Terephthalate) Guard : Cast brass or clear PC
 Globe : Clear hard glass (S90)
 LED : 3~8W Bulb type
 Cable entry : Flange seat (50A pipe)

Model no.	Capacity	L(mm)	W(mm)	H(mm)	Weight(kg)	Remarks
LEKHN-03WG-P	3W	155	144	262	1.24	E26/27
LEKHN-05WG-P	5W	677	144	262	1.24	E26/27
LEKHN-08WG-P	8W	1270	144	262	1.24	E26/27

- Optional : with Stainless steel Screen (LEKHN-*WU-P)

**LEBH-P****LED BRACKET LIGHT, 4HOLE IP56**

Engine room, workshop, stores, holds, outside passage ways
 Body : PBT (Poly Butylene Terephthalate) Guard : Cast brass or clear PC
 Globe : Clear hard glass (S90)
 LED : 3~8W Bulb type
 Cable entry : 2-Cable glands

Model no.	Capacity	L(mm)	W(mm)	H(mm)	Weight(kg)	Remarks
LEBH-03WG-P	3W	155	144	267	1.24	E26/27
LEBH-05WG-P	5W	155	144	267	1.24	E26/27
LEBH-08WG-P	8W	155	144	267	1.24	E26/27

- Optional : with Stainless steel Screen (LEBH-*WU-P)

LED LIGHTING FIXTURE FOR MARINE USE

**LEPN-B****LED PENDANT LIGHT IP56**

Engine room, workshop, stores, holds, outside passage ways

Body : Cast brass Guard : Cast brass

Globe : Clear hard glass (S90)

LED : 3~8W Bulb type

Cable entry : 2 Cable glands

Model no.	Capacity	L(mm)	W(mm)	H(mm)	Weight(kg)	Remarks
LEPN-03WG-B	3W	155	142	212	2.40	E26/27
LEPN-05WG-B	5W	155	142	212	2.40	E26/27
LEPN-08WG-B	8W	155	142	212	2.40	E26/27

• Optional : with Stainless steel Screen (LEPN-*WU-B)

**LEKN-B****LED BULKHEAD LIGHT, 4HOLE IP56**

Engine room, workshop, stores, holds, outside passage ways

Body : Cast brass Guard : Cast brass

Globe : Clear hard glass (S90)

LED : 3~8W Bulb type

Cable entry : Flange seat (50A pipe)

Model no.	Capacity	L(mm)	W(mm)	H(mm)	Weight(kg)	Remarks
LEKN-03WG-B	3W	153	105	233	1.66	Incand. bulb 20w
LEKN-05WG-B	5W	153	105	233	1.66	Incand. bulb 40w
LEKN-08WG-B	8W	153	105	233	1.66	Incand. bulb 60w

• Optional : with Stainless steel Screen (LEKN-*WU-B)

**LEBN-B****LED BRACKET LIGHT, 3HOLE IP56**

Engine room, workshop, stores, holds, outside passage ways

Body : Cast brass Guard : Cast brass

Globe : Clear hard glass (S90)

LED : 3~8W Bulb type

Cable entry : 2 Cable glands

Model no.	Capacity	L(mm)	W(mm)	H(mm)	Weight(kg)	Remarks
LEBN-03WG-B	3W	151	142	220	1.66	Incand. bulb 20w
LEBN-05WG-B	5W	151	142	220	1.66	Incand. bulb 40w
LEBN-08WG-B	8W	151	142	220	1.66	Incand. bulb 60w

• Optional : with Stainless steel Screen (LEBN-*WU-B)

**LEPH-9P****LED PENDANT LIGHT FOR DC24V IP56**

Engine room, workshop, stores, toilet

Body : PBT (Poly Butylene Terephthalate) Guard : PC

Globe : Clear hard glass

LED : 8W Module type

Cable entry : 2 Cable glands

Model no.	Capacity	L(mm)	W(mm)	H(mm)	Weight(kg)	Remarks
LEPH-08WG-9P	8W	114	144	171	0.64	Module type

LED LIGHTING FIXTURE FOR MARINE USE

**LEM-U****LED DOME LIGHT IP56**

Refrigerated chamber, workshop.
 Body : Stainless steel sheet deep drawn
 Globe : Clear hard glass
 LED : 0.2W LED Package
 Cable entry : 2 Cable glands

Model no.	Capacity	L(mm)	W(mm)	H(mm)	Weight(kg)	Remarks
LEM-12WG-U	12W	151	142	220	1.66	Module type

**LEDN-N****LED DOWN LIGHT IP20**
Flush type

Accommodation areas, saloon, lounge, public areas
 Body : Electro zinc galvanized steel sheet deep drawn
 Reflector : Silver plate
 LED : 5~8W Bulb type
 Cable entry : 2-Cable inlet hole

Model no.	Capacity	L(mm)	W(mm)	H(mm)	Weight(kg)	Remarks
LEDN-05N	5W	152	118	193	0.58	E26/27
LEDN-08N	8W	152	118	193	0.58	E26/27

- Optional : with Terminal box (LEDN-N-TB)

**LEDN-NL****LED DOWN LIGHT(FLUSH TYPE) IP20**

Accommodation areas, saloon, lounge, public areas
 Body : Electro zinc galvanized steel sheet deep drawn
 Reflector : Silver glass
 LED : 0.2W LED Package
 Cable entry : 3-Cable inlet hole

Model no.	Capacity	L(mm)	W(mm)	H(mm)	Weight(kg)	Remarks
LEDN-12NL	12W	312	176	74	1.11	Module type

- Optional : Dimming control type

**LECF-N****LED RECESSED ROUND LIGHT IP20**

Wheel house, radio & chart room
 Body : Electro zinc galvanized steel sheet deep drawn
 Reflector : Opal acryl
 LED : 0.2W LED Package
 Cable entry : 2-Cable inlet hole

Model no.	Capacity	L(mm)	W(mm)	H(mm)	Weight(kg)	Remarks
LECF-03N	3W	154	154	65	1.32	Module type

LED LIGHTING FIXTURE FOR MARINE USE

**LEDW-D****LED DECORATIVE WALL LIGHT IP20**
2 Tone color with dimming switch

Accommodation areas, saloon, lounge, public areas
 Body : Steel plate (silver / gold color plate)
 Diffuser : milky (acrylic)
 LED : 0.2W LED Package
 Cable entry : 1-Cable inlet hole (Max. 20mm dia cable)

Model no.	Capacity	L(mm)	W(mm)	H(mm)	Weight(kg)	Remarks
LEDW-14D	14W	150	110	300	1.80	module type

**LEDW-C****LED DECORATIVE WALL LIGHT IP20**
C Type

Accommodation areas, saloon, lounge, public areas
 Body : Steel plate (Golden color coating)
 Shade : Linen
 LED : 8W Bulb type
 Cable entry : 2-Cable inlet hole

Model no.	Capacity	L(mm)	W(mm)	H(mm)	Weight(kg)	Remarks
LEDW-08C	8W	298	Ø222	232	0.62	E26/27

**LETS****LED TABLE LIGHT W/cord IP20**
Dimmer touch switch

Accommodation areas, table
 Body : Steel plate (Golden color coating)
 Shade : Linen
 LED : 8W Bulb type
 Cable entry : Code & plug

Model no.	Capacity	L(mm)	W(mm)	H(mm)	Weight(kg)	Remarks
LETS-08	8W	180	Ø306	520	1.2	E26/27

**LED-SN****LED DESK LIGHT W/cord IP20**

Accommodation areas, desk top
 Body : ABS (Acrylonitrile Butadiene Styrene)
 Diffuser : Milky (polycarbonate)
 LED : 0.2W LED Package
 Cable entry : Code & plug

Model no.	Capacity	L(mm)	W(mm)	H(mm)	Weight(kg)	Remarks
LED-08SN	8W	350	170	510	1.26	Module type

LED LIGHTING FIXTURE FOR MARINE USE

**LEE-NF****LED EXIT LIGHT IP20**

Escape routes, direcyory signage
 Body : Electro zinc galvanized steel sheet
 Sign : Polycarbonate plate with different images
 LED : 0.2W LED Package
 Cable entry : 1-Cable inlet hole

Model no.	Capacity	L(mm)	W(mm)	H(mm)	Weight(kg)	Remarks
LEE-02NF	1.9W	230	105	200	1.80	

- Optional : with battery backup

**LEE-WS****LED EXIT LIGHT W/Terminal box IP44**

Escape routes, direcyory signage
 Body : Electro zinc galvanized steel sheet
 Sign : Polycarbonate plate with different images
 LED : 0.2W LED Package
 Cable entry : Cable box, 4-Cable glands

Model no.	Capacity	L(mm)	W(mm)	H(mm)	Weight(kg)	Remarks
LEE-05WS	4.5W	600	240	200	5.2	

- Optional : with battery backup

**LEH-W****LED PORTABLE HAND LIGHT IP56**

Engine room, workshop, stores,
 Body & Guard : Polycarbonate
 Globe : Clear hard glass
 LED : 5~8W Bulb type
 Cable entry : 1 Cable gland

Model no.	Capacity	L(mm)	W(mm)	H(mm)	Weight(kg)	Remarks
LEH-05W	5W	126	126	126	330	E26/27
LEH-08W	8W	126	126	330	1.05	E26/27

**LECTS(W)****LED CHART TABLE LIGHT W/dimm. IP20**

Wheel house, chart room
 Body : Aluminium sheet spinning, seamless & cast aluminum(T/B)
 Shade : Aluminium Diffuser : Polycarbonate
 LED : 0.2W LED Package
 Cable entry : 1-Cable inlet hole

Model no.	Capacity	L(mm)	W(mm)	H(mm)	Weight(kg)	Remarks
LECTS-08	8W	635	460	460	1.50	Stand type
LECTW-08	8W	635	460	460	1.50	Wall type

LED LIGHTING FIXTURE FOR MARINE USE

**LEPF*C****LED FLOOD LIGHT IP67**

Decks, holds and working areas
 Body : aluminium die-casting
 Front glass : tempered glass
 LED : 50W/80W C.O.B
 Cable entry : 1 Cable gland

Model no.	Capacity	L(mm)	W(mm)	H(mm)	Weight(kg)	Remarks
LEPF50C	50W	323	150	280	5.10	
LEPF80C	80W	323	150	280	5.10	

**LEPF*-U****LED FLOOD LIGHT (SUS COVER) IP67**

Decks, holds and working areas
 Body : aluminium die-casting & Stainless steel front cover
 Front glass : tempered glass
 LED : 1.6W LED Package
 Cable entry : 2 Cable glands

Model no.	Capacity	L(mm)	W(mm)	H(mm)	Weight(kg)	Remarks
LEPF80-U	80W	375	112	312	3.20	
LEPF120-U	120W	485	112	308	5.00	

**LEPF*-A****LED FLOOD LIGHT IP67**

Decks, holds and working areas
 Body : aluminium die-casting
 Front glass : tempered glass
 LED : 1.6W LED Package
 Cable entry : 2 Cable glands

Model no.	Capacity	L(mm)	W(mm)	H(mm)	Weight(kg)	Remarks
LEPF80-A	80W	438	136	320	4.80	
LEPF120-A	120W	438	136	320	4.80	

**LEPF*-84U****LED FLOOD LIGHT(SUS COVER) IP67**

Decks, holds and working areas
 Body : aluminium die-casting
 Front glass : tempered glass
 LED : 1.6W LED Package
 Cable entry : 2 Cable glands

Model no.	Capacity	L(mm)	W(mm)	H(mm)	Weight(kg)	Remarks
LEPF80-U	84W	438	136	320	4.80	

LED LIGHTING FIXTURE FOR MARINE USE

**LEPS150****LED SEARCH LIGHT IP56**

Bridge wing, Compass deck
 Body & cover : Stainless steel sheet Arm : sus or Steel chandal (zinc coating)
 Front glass : Heat and impact resistant glass
 LED : 2.3W LED Package
 Cable entry : 1 cable gland

Model no.	Capacity	L(mm)	W(mm)	H(mm)	Weight(kg)	Remarks
LEPS150	150W	478	395	714	18.5	

**LEPB****LED BOAT DECK LIGHT FOR DC24V IP56**

Boat deck area
 Body : cast brass
 Front glass : tempered glass
 LED : 1.6W LED Package
 Cable entry : 2 Cable glands

Model no.	Capacity	L(mm)	W(mm)	H(mm)	Weight(kg)	Remarks
LEPB-12	12W	191	169	236	4.11	Sealed beam 75w

**PBI-R****BOAT DECK LIGHT IP56**
Remote control type

Decks, holds and working areas
 Body : aluminium dai-casting & Stainless steel front cover
 Front glass : tempered glass
 LED : Sealed Beam 75W (DC24V)
 Sealed Beam 250W (AC220V)
 Cable entry : 2 Cable glands
 Remote control type

Model no.	Capacity	L(mm)	W(mm)	H(mm)	Weight(kg)	Remarks
PBI75-R	75W	375	112	312	3.20	
PBI250-R	250W	485	112	308	5.00	

**PB-RC****REMOTE CONTROL PANEL**
FOR LED BOAT DECK LIGHT

Wheel House
 Body : Steel Sheet
 Cable Entry : Coaming Hole
 PAN : 360°, MAX.6°±1° / SEC
 TILT : -80° ~ +30° MAX. 4° ± 1° / SEC

Model no.	Lamp	L(mm)	W(mm)	H(mm)	Weight(kg)	Remarks
PB-RC	Incan.	40	180	120	1.2	

LED LIGHTING FIXTURE FOR MARINE USE

**LEN-S** LED NAVIGATION LIGHT (SINGLE) IP56

All vessels of 20m and above in length
 Body : Polycarbonate (Seawater resistente materials)
 Lens : Polycarbonate
 LED : 1W LED Package
 Cable entry : 1 Cable gland

Model no.	Capacity	L(mm)	W(mm)	H(mm)	Weight(kg)	Remarks
LENM2A-S06W	6W	210	210	278	2.01	Masthead 225°
LENS2A-S04W	4W	210	210	278	2.13	stern 135°
LENP2A-S04R	4W	210	210	278	2.15	Port side 112.5°
LENT2A-S04G	4W	210	210	278	2.15	Starboard side 112.5°
LENY2A-S04Y	4W	210	210	278	1.82	Stern towing 135°

**LEN-D** LED NAVIGATION LIGHT (DUAL) IP56

All vessels of 50m and above in length
 Body : Polycarbonate (Seawater resistente materials)
 Lens : Polycarbonate
 LED : 1W LED Package
 Cable entry : 2 Cable gland

Model no.	Capacity	L(mm)	W(mm)	H(mm)	Weight(kg)	Remarks
LENM2A-D06W	6Wx2	210	210	478	3.72	Masthead 225°
LENS2A-D04W	4Wx2	210	210	478	3.96	Stem 135°
LENP2A-D04R	4Wx2	210	210	478	4.00	Port side 112.5°
LENT2A-D04G	4Wx2	210	210	478	4.00	Starboard 112.5°
LENY2A-D04Y	4Wx2	210	210	478	3.96	Stern towing 135°

**LEN-S** LED SIGNAL LIGHT (SINGLE) IP56

All vessels of 50m and above in length Allround 360°
 Body : Polycarbonate (Seawater resistente materials)
 Lens : Polycarbonate
 LED : 1W LED Package
 Cable entry : 1 Cable gland

Model no.	Capacity	L(mm)	W(mm)	H(mm)	Weight(kg)	Remarks
LENA2A-S06W	6W	210	210	278	1.82	Allround white 360°
LENU2A-S06W	6W	210	210	278	1.82	Allround red 360°
LENF2A-S06G	6W	210	210	278	1.82	Allround green 360°
LENV-S06W	6W	210	210	278	1.82	Maneuvring 360°

**LEN-D** LED SIGNAL LIGHT (DUAL) IP56

All vessels of 50m and above in length
 Body : Polycarbonate (Seawater resistente materials)
 Lens : Polycarbonate
 LED : 1W LED Package
 Cable entry : 1 Cable gland

Model no.	Capacity	L(mm)	W(mm)	H(mm)	Weight(kg)	Remarks
LENA2A-D06W	6Wx2	210	210	478	3.34	Allround white 360°
LENU2A-D06R	6Wx2	210	210	478	3.34	Allround red 360°
LENF2A-D06G	6Wx2	210	210	478	3.34	Allround green 360°

LED LIGHTING FIXTURE FOR MARINE USE

**LENH(G)-S****LED SIGNAL LIGHT IP56**

All vessels of 20m and above in length
 Body : Polycarbonate (Seawater resistant materials)
 Lens : Polycarbonate
 LED : 1W LED Package
 Cable entry : 1 Cable gland
 W/Control circuit board

Model no.	Capacity	L(mm)	W(mm)	H(mm)	Weight(kg)	Remarks
LENH-S10G HUGE VESSEL LIGHT	6W	210	210	278	2.05	Green 180~200F/min
LENG-S10R DANGEROUS CARGO LIGHT	6W	210	210	278	2.05	Red 120~140F/min

**LESL-C****LED SUZE SIGNAL LIGHT IP56**

Ship passage for Suez canal
 Body : Polycarbonate
 Globe : Hard glass (clear, red, green)
 LED : 5W Bulb type
 Cable entry : 1 Cable gland

Model no.	Capacity	L(mm)	W(mm)	H(mm)	Weight(kg)	Remarks
LESL-C05W	5W	178	162	190	1.60	White
LESL-C05R	5W	178	162	190	1.60	Red
LESL-C05G	5W	178	162	190	1.60	Green

**LESL-S****LED PANAMA STEERING LIGHT IP56**

Ship passage for Panama canal
 Body : Polycarbonate
 Globe : Hard glass (blue)
 LED : 5W Bulb type
 Cable entry : 1 Cable gland

Model no.	Capacity	L(mm)	W(mm)	H(mm)	Weight(kg)	Remarks
LESL-S05B	5W	178	162	190	1.65	Blue

**LESL-P****LED WARNING LIGHT IP56**

Hanging type

Weather deck, engine room, refrigerated hold
 Body & Guard : cast brass
 Globe : Flange type hard glass (clear, red, green, yellow)
 LED : 5W Bulb type
 Cable entry : 2 Cable glands

Model no.	Capacity	L(mm)	W(mm)	H(mm)	Weight(kg)	Remarks
LESL-P05R	5W	105	105	270	2.51	Red
LESL-P05G	5W	105	105	270	2.51	Green
LESL-P05Y	5W	105	105	270	2.51	Yellow



Control Panel for Navigation light IP22

Separated Lighting Function
 Function to check a status of each light and alarm indicating
 Back Lighting to Name Plate
 Rotary Type Analog Dimmer
 LED and Buzzer test
 External Input/Output to alarm, system fault, etc.,

Model no.	Capacity	L(mm)	W(mm)	H(mm)	Weight(kg)	Remarks
Navigation Panel	AC220/230V	310	221	182	4.0	



Control Panel for Signal light IP22

Separated Lighting Function
 Function to check a status of each light and alarm indicating
 Back Lighting to Name Plate
 Dimmer for Steering Light
 Rotary Type Analog Dimmer
 LED and Buzzer test

Model no.	Capacity	L(mm)	W(mm)	H(mm)	Weight(kg)	Remarks
Signal Panel	AC220/230V	310	221	182	4.0	

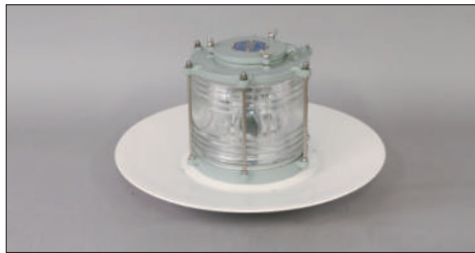

LES-L-M

LED MORSE SIGNAL LIGHT IP56

Morse signal
 Body : cast brass
 Globe : Hard glass (Clear)
 LED : 2.5W Blub type
 Cable entry : 1 Cable gland

Model no.	Capacity	L(mm)	W(mm)	H(mm)	Weight(kg)	Remarks
LES-L-M23	2Wx3	Ø300	Ø200	216	5.00	FB15
LES-L-M54	5Wx4	Ø500	Ø200	261	10.40	E26/27

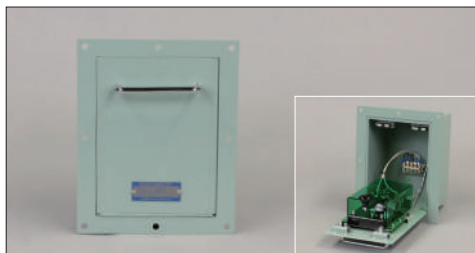

MK-FS

MORSE KEY IP20 Flush type

Morse Signalling System
 Body : Electrolytic Galvanized Iron steel sheet
 Cable entry : 1 Snap Bushing

Model no.	Capacity	L(mm)	W(mm)	H(mm)	Weight(kg)	Remarks
MK-FS	5A	260	210	132	3.8	

LED LIGHTING FIXTURE FOR MARINE USE



LEXd-Y
Ex-d IIC T6

LED EX-P. CYLINDER LIGHT IP67

Hazardous areas, Zone 1 and 2 Ex "d" flameproof enclosure
 Body : Cast aluminium alloy
 Globe : Clear Polycarbonate
 LED : 0.2W LED Package
 Cable entry : 2 or 4 Cable glands

Model no.	Capacity	L(mm)	W(mm)	H(mm)	Weight(kg)	Remarks
LEXd-Y152	30W	786	180	210	7.90	
LEXd-Y292	58W	1396	180	210	10.60	



LEXd-P
Ex-de IIC T5, T6

LED EX-PROOF PENDANT LIGHT IP66

Hazardous areas, Zone 1 and 2 Ex "d" flameproof enclosure
 Body : Cast brass / aluminium
 Globe : Clear Tempered glass
 LED : 8W~12W Bulb type
 Cable entry : 2 or 4 Cable glands

Model no.	Capacity	L(mm)	W(mm)	H(mm)	Weight(kg)	Remarks
LEXd-P08	8W	235	250	280	6.10	
LEXd-P12	12W	235	250	280	6.10	



LEXd-PF
Ex-d IIB T5

LED EX-PROOF LIGHT IP66

Hazardous areas, Zone 1 and 2 Ex "d" flameproof enclosure
 Body : Cast brass / aluminium
 Globe : Clear Tempered glass
 LED : 1W LED Package
 Cable entry : 1 Cable gland

Model no.	Capacity	L(mm)	W(mm)	H(mm)	Weight(kg)	Remarks
LEXd-PF80	80W	405	175	312	5.50	

Optimized Management of Spare Parts

- Easy Installation & Maintenance
- Applicable to Various Kinds of Luminaire



A close-up, artistic photograph of a lighting fixture lens. The lens is circular and made of clear glass or plastic, showing concentric rings and reflections of light. The background is dark, making the lens stand out. The text "LIGHTING FIXTURE FOR ON DECK" is centered over the lens, flanked by two horizontal white lines.

**LIGHTING FIXTURE
FOR ON DECK**

LIGHTING FIXTURE FOR ON-DECK



PFH-20 HALOGEN FLOOD LIGHT LIGHT IP67
Narrow beam

Decks, holds and working areas
 Body & cover : Stainless steel
 Front glass : tempered glass
 Reflector : Highly polished aluminium, anodized
 Cable entry : 2 cable glands

Model no.	Capacity	L(mm)	W(mm)	H(mm)	Weight(kg)	Remarks
PFH-20	200W	283	143	321	2.90	R7s



PFH-30 HALOGEN FLOOD LIGHT IP67
Narrow & wide beam

Decks, holds and working areas
 Body & cover : Stainless steel
 Front glass : tempered glass Terminal box : PC
 Reflector : Highly polished aluminium, anodized
 Cable entry : 2 cable glands

Model no.	Capacity	L(mm)	W(mm)	H(mm)	Weight(kg)	Remarks
PFH-30N	300W	334	181	350	6.21	R7s, Narrow
PFH-30W	300W	334	181	350	6.21	R7s, Wide



PFH-50 HALOGEN FLOOD LIGHT IP67
Narrow & wide beam

Decks, holds and working areas
 Body & cover : Stainless steel deep drawn
 Front glass : tempered glass Terminal box : PC
 Reflector : Highly polished aluminium, anodized
 Cable entry : 2 cable glands

Model no.	Capacity	L(mm)	W(mm)	H(mm)	Weight(kg)	Remarks
PFH-50N	500W	444	181	350	7.62	E39/E40, Narrow
PFH-50W	500W	444	181	350	7.62	E39/E40, Wide



PFH-1K HALOGEN FLOOD LIGHT IP67
Narrow & wide beam

Decks, holds and working areas
 Body & cover : Stainless steel deep drawn
 Front glass : tempered glass Terminal box : Stainless steel
 Reflector : Highly polished aluminium, anodized
 Cable entry : 2 cable glands

Model no.	Capacity	L(mm)	W(mm)	H(mm)	Weight(kg)	Remarks
PFH-1KN	1000W	444	185	520	13.2	E39/E40, Narrow
PFH-1KW	1000W	444	185	520	13.2	E39/E40, Wide

LIGHTING FIXTURE FOR ON-DECK



PFSI-40

H.P SODIUM FLOOD LIGHT IP67
Narrow & wide beam

Decks, holds and working areas
Body & cover : Stainless steel
Front glass : tempered glass Terminal box : PBT
Reflector : Highly polished aluminium, anodized
Cable entry : 2 cable glands

Model no.	Capacity	L(mm)	W(mm)	H(mm)	Weight(kg)	Remarks
PFSI-40N	400W	444	181	398	7.62	E39/E40, Narrow
PFSI-40W	400W	444	181	398	7.62	E39/E40, Wide

• Optional : Metal halide lamp 400w (PFMH-40)



PFSI-42

H.P SODIUM FLOOD LIGHT IP67
Narrow & wide beam

Decks, holds and working areas
Body & cover : Stainless steel
Front glass : tempered glass Terminal box : Stainless steel
Reflector : Highly polished aluminium, anodized
Cable entry : 2 cable glands

Model no.	Capacity	L(mm)	W(mm)	H(mm)	Weight(kg)	Remarks
PFSI-42N	400Wx2	444	185	520	13.2	
PFSI-42W	400Wx2	444	185	520	13.2	

• Optional : Metal halide lamp 400wX2 (PFMH-42)



PFSI-IP68

H.P SODIUM FLOOD LIGHT IP68
Under-water flood light (5meter)

Floating dock
Body : Stainless steel sheet Front cover : Cast brass
Front glass : tempered glass
Reflector : Highly polished aluminium, anodized
Cable entry : 1 cable gland

Model no.	Capacity	L(mm)	W(mm)	H(mm)	Weight(kg)	Remarks
PFSI-40N-IP68	400W	502	190	384	27.0	E39/E40 Narrow

• Optional : Metal halide lamp 400w (PFMH-40-IP60)



PFM(SI)*-J

FLOOD LIGHT IP56
Mercury & sodium lamp

Decks, holds and working areas
Body : Stainless steel
Front glass : tempered glass Terminal box : Stainless steel
Reflector : Highly polished aluminium, anodized
Cable entry : 1 cable gland

Model no.	Capacity	L(mm)	W(mm)	H(mm)	Weight(kg)	Remarks
PFM-40-J	400W	405	478	607	12.5	Mercury
PFSI-40-J	400W	405	478	607	12.5	H.P.Sodium
PFM-70-J	700W	543	593	735	16.5	Mercury
PFSI-70-J	660W	543	593	735	16.5	H.P.Sodium

**PFI-20****INCANDESCENT FLOOD LIGHT IP56**

Decks, holds and working areas
 Body & cover : Stainless steel
 Front glass : tempered glass Terminal box : Cast brass
 Reflector : Highly polished aluminium, anodized
 Cable entry : 1 cable gland

Model no.	Capacity	L(mm)	W(mm)	H(mm)	Weight(kg)	Remarks
PFI-20	200W	261	278	354	4.92	E26/E27

**PFI-30/50****INCANDESCENT FLOOD LIGHT IP56**

Decks, holds and working areas
 Body & cover : Stainless steel
 Front glass : tempered glass Terminal box : Cast brass
 Reflector : Highly polished aluminium, anodized
 Cable entry : 1 cable gland

Model no.	Capacity	L(mm)	W(mm)	H(mm)	Weight(kg)	Remarks
PFI-30	300W	405	470	517	11.2	E39/E40
PFI-50	500W	405	470	517	11.2	E39/E40

**PFM-40/70****MERCURY FLOOD LIGHT IP56**

Decks, holds and working areas
 Body & cover : Stainless steel
 Front glass : tempered glass Terminal box : Cast Brass
 Reflector : Highly polished aluminium, anodized
 Cable entry : 1 cable gland

Model no.	Capacity	L(mm)	W(mm)	H(mm)	Weight(kg)	Remarks
PHM-40	400W	405	470	517	11.2	E39/E40
PHM-70	700W	543	550	664	15.5	E39/E40

**PFIP/PFHP****PORTABLE FLOOD LIGHT IP56**
Incan. & Haligen LAMP

Decks, holds and working areas
 Body & cover : Stainless steel
 Front glass : tempered glass Terminal box : Stainless steel
 Reflector : Highly polished aluminium, anodized
 Cable entry : 1 cable gland

Model no.	Capacity	L(mm)	W(mm)	H(mm)	Weight(kg)	Remarks
PFIP-30	300W	405	405	475	8.30	E40, Incan.
PFIP-50	500W	405	405	475	8.30	E40, Incan.
PFHP-50	500W	405	405	475	8.30	E40, Halogen

• Optional : with 20m cable (TPNP-1.5), & plug

LIGHTING FIXTURE FOR ON-DECK



PBI

BOAT DECK LIGHT IP56
DC24V Sealed beam lamp

Boat deck area
Body & cover : cast brass
Arm : Stainless steel
Cable entry : 1 cable gland

Model no.	Capacity	L(mm)	W(mm)	H(mm)	Weight(kg)	Remarks
PBI-75	75W	191	169	236	4.11	



PPI/PPM

PROJECTOR LIGHT IP56

Decks, holds and working areas
Body & cover : Stainless steel
Guard : Stainless steel
Lamp : Reflector type lamp
Cable entry : 1 cable gland

Model no.	Capacity	L(mm)	W(mm)	H(mm)	Weight(kg)	Remarks
PPI-30	300W	246	420	350	4.30	E39/E40, INCAN.
PPI-50	500W	246	420	350	4.30	E39/E40, INCAN.
PPM-40	400W	246	420	350	4.30	E39/E40, Mercury
PPM-70	700w	366	524	436	6.43	E39/E40, Mercury



PPIS/PPMS

PROJECTOR LIGHT W/SHADE IP56

Decks, holds and working areas
Body & cover : Stainless steel
Guard : Stainless steel
Lamp : Reflector type lamp
Cable entry : 1 cable gland

Model no.	Capacity	L(mm)	W(mm)	H(mm)	Weight(kg)	Remarks
PPI-30	300W	246	420	350	4.30	E39/E40, INCAN.
PPIS-50	500W	246	420	350	4.30	E39/E40, INCAN.
PPMS-40	400W	346	420	350	4.30	E39/E40, Mercury
PPMS-70	700W	366	524	436	6.43	E39/E40, Mercury



PPIP

PROJECTOR LIGHT PORTABLE TYPE IP56

Decks, holds and working areas
Body & cover : Stainless steel
Guard : Stainless steel
Lamp : Reflector type lamp
Cable entry : 1 cable gland

Model no.	Capacity	L(mm)	W(mm)	H(mm)	Weight(kg)	Remarks
PPIP-30	300W	246	420	350	4.30	E39/E40, INCAN.
PPIP-50	500W	246	420	350	4.30	E39/E40, INCAN.

LIGHTING FIXTURE FOR ON-DECK

**BT*S-S****BALLAST BOX IP56**

Decks and holds, engine room
 Body & cover : Steel deep drawn
 Cable entry : 3 cable glands

Model no.	Capacity	L(mm)	W(mm)	H(mm)	Weight(kg)	Remarks
BT40S-S	1x400W	234	444	136	9.70	H.P. sodium
BT42S-S	2x400W	234	444	136	15.20	H.P. sodium

**BT*S-U****BALLAST BOX IP56**

Decks and holds, engine room
 Body & cover : Stainless steel deep drawn
 Cable entry : 3 Cable glands

Model no.	Capacity	L(mm)	W(mm)	H(mm)	Weight(kg)	Remarks
BT40S-U	1x400W	234	444	136	9.70	H.P. sodium
BT42S-U	2x400W	234	444	136	15.20	H.P. sodium

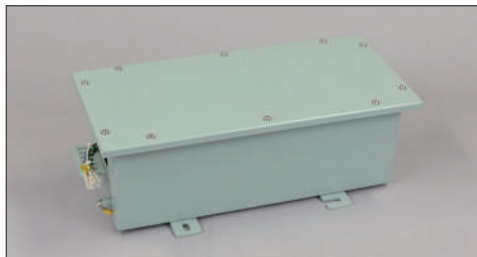
**BT*M-BC****BALLAST BOX IP44**

Decks and holds, engine room
 Body & cover : Steel deep drawn
 Cable entry : Cable coaming hole

Model no.	Capacity	L(mm)	W(mm)	H(mm)	Weight(kg)	Remarks
BT40M-BC	1x400W	484	224	134	11.7	Mercury
BT70M-BC	1x700W	484	224	184	13.7	Mercury

- Optional : Ballast box Metal halide light

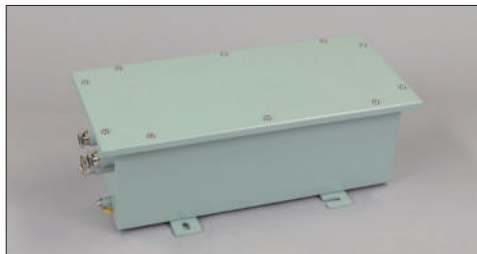
**BT*M-B****BALLAST BOX IP56**

Decks and holds, engine room
 Body & cover : Steel deep drawn
 Cable entry : 3 Cable glands

Model no.	Capacity	L(mm)	W(mm)	H(mm)	Weight(kg)	Remarks
BT40M-B	1x400W	484	224	134	11.7	Mercury
BT70M-B	1x700W	484	224	184	13.7	Mercury

- Optional : Ballast box Metal halide light

LIGHTING FIXTURE FOR ON-DECK



PSHF **HALOGEN SEARCH LIGHT IP56**
Fixed type

Bridge wing, Compass deck
 Body & cover : Stainless steel sheet Arm : sus or Steel chanal (zinc coating)
 Reflector : Glass parabolic mirror
 Front glass : Heat and impact resistant glass
 Cable entry : 1 cable gland (M24x1.5)

Model no.	Capacity	L(mm)	W(mm)	H(mm)	Weight(kg)	Remarks
PSHF-1K	1000W	425	344	583	16.5	Lamp base :GX9.5
PSHF-2K	2000W	692	630	997	60.0	Lamp base :GX16
PSHF-3K	3000W	692	630	997	60.0	Lamp base :GX38



PSHC **HALOGEN SEARCH LIGHT IP56**
Room control type

Bridge wing, Compass deck
 Body & cover : Stainless steel sheet Arm : SUS or Steel chanal (zinc coating)
 Reflector : Glass parabolic mirror Control handle : Cast brass & Plastic
 Front glass : Heat and impact resistant glass
 Cable entry : 1 cable gland (M24x1.5)

Model no.	Capacity	L(mm)	W(mm)	H(mm)	Weight(kg)	Remarks
PSHC-1K	1000W	425	344	583	16.5	Lamp base :GX9.5
PSHC-2K	2000W	692	630	997	60.0	Lamp base :GX16



PSHR **HALOGEN SEARCH LIGHT IP56**
Electronic remote control type

Bridge wing, Compass deck
 Body & cover : Stainless steel sheet Arm : sus or Steel chanal (zinc coating)
 Reflector : Glass parabolic mirror Mounting box : Stainless steel
 Front glass : Heat and impact resistant glass
 Cable entry : 1 cable gland (M24x1.5)

Model no.	Capacity	L(mm)	W(mm)	H(mm)	Weight(kg)	Remarks
PSHR-1K	1000W	425	344	915	50.0	Lamp base :GX9.5
PSHR-2K	2000W	692	630	1545	155.0	Lamp base :GX16
PSHR-3K	3000W	692	630	1545	155.0	Lamp base :GX38



PSHR-RC **ROMOTE CONTROL PANEL IP20**
Flush type

Wheel house
 Front plate : Aluminium (Purple blue screen prints)
 Cable entry : Coming hole
 Romete control Switch for lamp on-off, angle up-down, left-right

Model no.	L(mm)	W(mm)	H(mm)	Weight(kg)	Remarks
PSHR-RC	220	130	50	0.8	

LIGHTING FIXTURE FOR ON-DECK



PSXR

XENON SEARCH LIGHT IP56
Electronic remote control type

Bridge wing, Compass deck
 Body & cover : Stainless steel sheet Arm : Steel chandal (zinc coating)
 Reflector : Glass parabolic mirror Mounting box : Stainless steel
 Front glass : Heat and impact resistant glass
 Cable entry : 3 cable glands

Specification

Light sources : Xenon lamp / 1,000W~7,000W
 Lamp base : Maker supply / Lamp capacity : DC24V
 Horizontal rotation 350° , 11 /sec
 Vertical movement upward 20° / downward 40° ,3 /sec
 Cable entry : Three(3) cable glands
 (Max.diameter 17mm cable)
 Mounting : 4 mounting holes, dia. 13mm~17mm
 Voltage and frequency

Model no.	Capacity	L(mm)	W(mm)	H(mm)	Weight(kg)	Range(m)
PSXR-1K	1000W	605	496	1284	105.0	6300
PSXR-1.6K	1600W	605	496	1284	105.0	7500
PSXR-2K	2000W	750	656	1638	140.0	8000
PSXR-2.5K	2500W	750	656	1638	140.0	8800
PSXR-3K	3000W	750	656	1638	140.0	9900
PSXR-4.5K	4500W	810	730	1720	160.0	12000
PSXR-7K	7000W	860	780	1820	175.0	14500



PU-X

POWER SUPPLY UNIT IP22

Wheel house
 Body : Steel sheet
 Front plate : Aluminium (Purple blue screen prints)
 Cable entry : Coming hole
 Voltage & frequency : AC100~240V, 60Hz Finished : Maker standard

Model no.	Capacity	L(mm)	W(mm)	H(mm)	Weight(kg)	Remarks
PU-X1K0	1000W	420	255	285	12.0	
PU-X1.6K	1600W	420	255	285	13.0	
PU-X2K0	2000W	420	270	300	14.0	
PU-X2.5K	2500W	420	270	300	22.5	
PU-X3K0	3000W	420	270	300	22.5	
PU-X4.5K	4500W	515	400	390	36.5	
PU-X7K0	7000W	515	400	390	36.5	



PSXR-RC

REMOTE CONTROL PANEL IP20
Flush type

Wheel house
 Body : Steel sheet
 Front plate : Aluminium (Purple blue screen prints)
 Cable entry : Coming hole

Model no.	L(mm)	W(mm)	H(mm)	Weight(kg)	Remarks
PSXR-RC	220	130	113	1.2	

LIGHTING FIXTURE FOR ON-DECK



PCH SUEZ CANAL SEARCH LIGHT IP56

ABS CERTIFICATION

All sea going vessels transiting suez canal
 Body & cover : Stainless steel sheet
 Reflector : Split silver- plated parabolic mirror
 Front glass : Heat and impact resistant glass
 Cable entry : 1-Cable gland (M24x1.5)
 Lamp : Halogen lamp

Specification

Light sources : Halogen lamp / 2,000W, 3,000W
 Lamp base : G38 / Horizontal rotation 350°
 Vertical movement upward 40° / downward 35°
 Cable entry : One(1) cable glands M24x1.5
 (Max.diameter 17mm cable)
 Mounting : 6 mounting holes, dia. 19mm
 Voltage and frequency : AC220V 60Hz are standard
 Others on request

Model no.	Capacity	L (mm)	W (mm)	H (mm)	Weight (kg)	Range (m)
PCH-2K	2000W	607	786	1113	62.5	2180
PCH-3K	3000W	607	786	1113	62.5	2230



RTSC-30P RECEPTACLE W/SWITCH & PLUG IP56

Ex-d IIB T6

For Suez canal search light

Ship's passage for suez canal Ex "d" Flame-proof enclosure
 Body & cover : cast aluminium alloy (AC7A)
 Receptacle : 3P+1E with interlock device
 Cable entry : 1-Cable gland (NPT3/4")
 Voltage : AC250V Finished : Maker standard

Model no.	Capacity	L(mm)	W(mm)	H(mm)	Weight(kg)	Remarks
RTSC-30P	30A	205	235	533	10.5	

• Optional : Material : Cast brass



PZHF HALOGEN SEARCH LIGHT IP56

With signalling shutter type

Bridge wing, Compass deck
 Body & cover : Stainless steel sheet Arm : Steel chanel (zinc coating)
 Reflector : Glass parabolic mirror Shutter box : Stainless steel
 Front glass : Heat and impact resistant glass
 Cable entry : 1 cable gland (M24x1.5)

Model no.	Capacity	L(mm)	W(mm)	H(mm)	Weight(kg)	Remarks
PZHF-1K	1000W	578	369	664	34.0	



KD-26X

26" XENON SEARCH LIGHT IP56
For Military equipment

Night Guard for Coastal Areas, Inducement of Ship to port.

Specification

Lighting fixture

Operation method : manual
 Light source : Xenon lamp (2000W)
 Input power : DC27V ± 2(70A)
 Output : 1,900W ~ 2,000W
 Candle power : 80,000,000 cd
 Weight : 160kg
 Dimensions : 920 x 1,005 x 1,585 mm(LxWxH)

Ballast box

Operatoion method : manual
 Power consumption : 5KVA
 Input power : AC110/220V, DC 36V(battery)
 Output power : DC28V±1V, 70A, 2KW
 Weight : 120kg
 Dimensions : 510 x 430 x 835 mm (LxWxH)
 AC electrical characteristics
 Current range : 70A±5(max.)
 Voltage range : 110V/220V±10%(max.)
 Voltage ripple: 50mV(max.)
 DC electrical characteristics
 Charge current : 50A(max.) ~ 2A(min.)
 Charge voltage : 39V~45V
 Battery voltage : 31.5V
 Battery charging time : 12hr
 Battery working time : 2hr



Battery

12V 250Ah : 3ea (260kg)
 Continuous operation : 12hr(AC), 2hr(DC)
 Once charging time : 12hr
 Power consumption : 7.5KW
 Built-in portection circuit

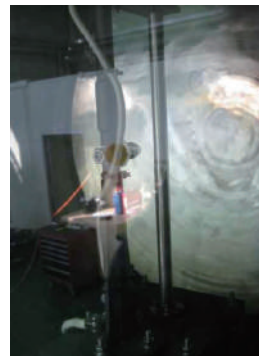

**KDMSL-500-11****SURVEILLANCE LIGHT IP66**
With 2 HMI discharge lamps

Body & cover : Stainless steel sheet
 Reflector : Split silver- plated parabolic mirror
 Front glass : Heat and impact resistant glass
 Slipping type
 Lamp : 575Wx2 (MH)

Model no.	Capacity	L(mm)	W(mm)	H(mm)	Weight(kg)	Remarks
KDMSL-500-11	575x2	1170	590	830	120	

**KDMSL-500-12****SURVEILLANCE LIGHT IP66**

Body & cover : Stainless steel sheet
 Reflector : Split silver- plated parabolic mirror
 Front glass : Heat and impact resistant glass
 Slipping type
 Lamp : 575Wx1 (MH)
 575Wx1 (UV)

Model no.	Capacity	L(mm)	W(mm)	H(mm)	Weight(kg)	Remarks
KDMSL-500-12	575x2	1170	590	830	120	

**KDMSL-500-22****SURVEILLANCE LIGHT IP66**
with 2 UV lamp

Body & cover : Stainless steel sheet
 Reflector : Split silver- plated parabolic mirror
 Front glass : Heat and impact resistant glass
 Slipping type
 Lamp : 575Wx2 (UV)

Model no.	Capacity	L(mm)	W(mm)	H(mm)	Weight(kg)	Remarks
KDMAL-500-22	575x2	1170	590	830	120	

Marine Searchlight

Unlimited Movement (360°)

Direct the searchlight anywhere without any limitations, vertically and horizontally at the same time

UV(Ultra Violet) Light

For safe navigation, search and rescue, oil spill detection, and helicopter landing

LIGHTING FIXTURE FOR EXPLOSION-PROOF

HAZARDOUS
POTENTIAL
DO NOT OPEN

UL LISTED
EEX d IIC T4
150W
120V
50/60Hz
IP65
3000K
50000Hrs
Eaton
Eaton Lighting
Eaton Lighting Co. Inc.
Eaton Lighting Co. Inc.
Eaton Lighting Co. Inc.

**IX-20d****INCANDESCENT PENDANT LIGHT IP66**

Ex-d IIC T5

Hazardous areas, Zone 1 and 2, Ex "d" Flameproof enclosure

Body : Cast brass / aluminium

Globe : Clear polycarbonate

Reflector : Internal high polished aluminium anodized

Cable entry : 1 or 2 Cable gland

Model no.	Capacity	L(mm)	W(mm)	H(mm)	Weight(kg)	Remarks
IX-20d	20W	158	250	170	1.60	B15

**IX-d****INCANDESCENT PENDANT LIGHT IP66**

Ex-de IIC T4

Hazardous areas, Zone 1 and 2, Ex "d" Flameproof enclosure

Body : Cast brass / aluminium

Globe : Clear polycarbonate

Reflector : Internal high polished aluminium anodized

Cable entry : 1 or 2 Cable gland

Model no.	Capacity	L(mm)	W(mm)	H(mm)	Weight(kg)	Remarks
IX-60d	60W	235	250	223	4.20	E26/E27
IX-00d	100W	235	250	223	4.20	E26/E27

**IXF-d****INCAN. / FL. PENDANT LIGHT IP66**

Ex-de IIC T5, T6

Hazardous areas, Zone 1 and 2, Ex "d" Flameproof enclosure

Body : Cast brass / aluminium

Globe : Clear tempered glass

Reflector : Internal high polished aluminium anodized

Cable entry : 1 or 2 Cable gland

Model no.	Capacity	L(mm)	W(mm)	H(mm)	Weight(kg)	Remarks
IXF-60d	60W	235	250	280	6.10	E26/E27, T5
IXF-00d	100W	235	250	280	6.10	E26/E27, T5
IXF-23d	FL 23W	235	250	280	6.10	E26/E27, T6

**IX1-d****INCAN./FL. PENDANT LIGHT IP66**

Ex-d IIB T3

Hazardous areas, Zone 1 and 2, Ex "d" Flameproof enclosure

Body : Cast brass

Globe : Clear tempered glass

Cable entry : 1 or 2 Cable gland

Model no.	Capacity	L(mm)	W(mm)	H(mm)	Weight(kg)	Remarks
IX1-00d	100W	215	142	230	3.20	E26/E27, T3
IX1-23d	FL 23W	215	142	230	3.30	E26/E27, T5

**PX-I**

Ex-de IIC T4

INCANDESCENT FLOOD LIGHT IP66

With Hanging hook

Hazardous areas, Zone 1 and 2, Ex "d" Flameproof enclosure

Body : Cast aluminium alloy

Globe : Clear tempered glass

Reflector : Internal high polished aluminium anodized

Cable entry : 1 or 2 Cable gland

Model no.	Capacity	L (mm)	W (mm)	H (mm)	Weight (kg)	Remarks
PX-I30d	300W	450	529	528	24.0	E39/E40
PX-I50d	500W	450	529	528	24.0	E39/E40

**PXC-S(M)**

Ex-de IIC T4

H.P. SODIUM FLOOD LIGHT IP66

Metal halide flood light

Hazardous areas, Zone 1 and 2, Ex "d" Flameproof enclosure

Body : Cast aluminium alloy

Globe : Clear tempered glass

Reflector : Internal high polished aluminium anodized

Cable entry : 1 or 2 Cable gland

Model no.	Capacity	L(mm)	W(mm)	H(mm)	Weight(kg)	Remarks
PXC-S40d	400W	428	633	536	39.0	E39/E40
PXC-M40d	400W	428	633	536	39.0	E39/E40

**PX-S(H)**

Ex-de IIB T3

H.P. SODIUM FLOOD LIGHT IP66

Halogen flood light

Hazardous areas, Zone 1 and 2, Ex "d" Flameproof enclosure

Body : Cast aluminium alloy

Globe : Clear tempered glass

Reflector : Internal high polished aluminium anodized

Cable entry : 1 or 2 Cable gland

Model no.	Capacity	L(mm)	W(mm)	H(mm)	Weight(kg)	Remarks
PX-S40d	400W	474	271	410	29.0	E39/E40, H.P.Sodium
PX-H30d	300W	474	271	410	26.3	R7s, Halogen
PX-H50d	500W	474	271	410	26.3	R7s, Halogen

**FX-d**

Ex-d IIC T6

FLUORESCENT LIGHT IP67

Hazardous areas, Zone 1 and 2, Ex "d" Flameproof enclosure

Body : Cast aluminium alloy

Globe : Clear polycarbonate

Cable entry : 2 or 4 Cable gland

Model no.	Capacity	L(mm)	W(mm)	H(mm)	Weight(kg)	Remarks
FX-220d	18Wx2	790	185	185	7.9	G13
FX-420d	36Wx2	1380	185	185	10.8	G13

**FX-edm**

Ex-de mb IIC T4

FLUORESCENT CEILING LIGHT IP66

Hazardous areas, Zone 1 and 2, Ex "e" Increased safety
 Body : Stainless steel sheet deep drawn
 Diffuser : Milky / clear polycarbonate
 Quick Start, Electronic ballast
 Cable entry : 2 or 4 Cable glands

Model no.	Capacity	L(mm)	W(mm)	H(mm)	Weight(kg)	Remarks
FX-220edm	18Wx2	715	223	133	4.28	G13
FX-420edm	36Wx2	1350	223	133	6.18	G13

- Optional : Battery back up to 180 min.

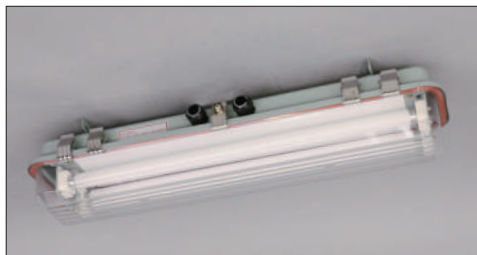
**FX-edm-H**

Ex-de mb IIC T4

FLUORESCENT CEILING LIGHT IP66

Hazardous areas, Zone 1 and 2, Ex "e" Increased safety
 Body : Stainless steel sheet deep drawn
 Diffuser : Milky / clear polycarbonate Latch : Stainless steel
 Quick Start, Electronic ballast
 Interlock switch
 Cable entry : 2 or 4 Cable glands

Model no.	Capacity	L(mm)	W(mm)	H(mm)	Weight(kg)	Remarks
FX-220edm-H	20Wx2	715	223	133	4.28	G13
FX-420edm-H	40Wx2	1350	223	133	6.18	G13

**FX-edm-F**

Ex-de mb IIC T4

FL. NO-GAP CEILING LIGHT IP54

Recessed type

Hazardous areas, Zone 1 and 2, Ex "e" Increased safety
 Body : Electrolytic Galvanized Iron steel sheet deep drawn
 Diffuser : Milky polycarbonate
 Interlock switch
 Cable entry : 4 Cable glands

Model no.	Capacity	L(mm)	W(mm)	H(mm)	Weight(kg)	Remarks
FX-220edm-F	20Wx2	667	275	111	12.5	G13
FX-420edm-F	40Wx2	1270	275	111	13.7	G13

- Optional : Battery back up to 180 min. W/Louver

**FX-edm-C**

Ex-de mb IIC T4

FL. GAP CEILING LIGHT IP54

Recessed type

Hazardous areas, Zone 1 and 2, Ex "e" Increased safety
 Body : Electrolytic Galvanized Iron steel sheet deep drawn
 Diffuser : Milky polycarbonate
 Interlock switch
 Cable entry : 4 Cable glands

Model no.	Capacity	L(mm)	W(mm)	H(mm)	Weight(kg)	Remarks
FX-220edm-C	18Wx2	660	275	125	10.60	G13
FX-420edm-C	36Wx2	1270	275	125	17.40	G13

- Optional : Battery back up to 180 min. W/Louver

LIGHTING FIXTURE FOR EXPLOSION-PROOF

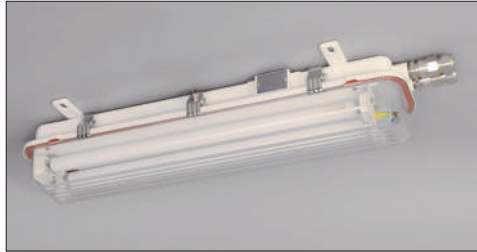

FX-nA
Ex-nA IIC T5

FLUORESCENT CEILING LIGHT IP66

Hazardous areas, Zone 2, Ex "nA" Non sparking
 Body : Stainless steel sheet deep drawn
 Diffuser : Milky / clear polycarbonate
 Electronic ballast
 Cable entry : 2 or 4 Cable glands

Model no.	Capacity	L (mm)	W (mm)	H (mm)	Weight (kg)	Remarks
FX-220nA	18Wx2	715	223	133	4.28	G13
FX-420nA	36Wx2	1350	223	133	6.18	G13

• Optional : Battery back up to 180 min.



FX-nA-F
Ex-nA IIC T5

FL. NO-GAP CEILING LIGHT IP54
Recessed type

Hazardous areas, Zone 2, Ex "nA" Non sparking
 Body : Electrolytic Galvanized Iron steel sheet deep drawn
 Diffuser : Milky polycarbonate
 Cable entry : 4 Cable glands

Model no.	Capacity	L(mm)	W(mm)	H(mm)	Weight(kg)	Remarks
FX-220nA-F	18Wx2	667	275	111	12.5	G13
FX-420nA-F	36Wx2	1270	275	111	13.7	G13

• Optional : Battery back up to 180 min.



FX-nA-C
Ex-nA IIC T5

FL. GAP CEILING LIGHT IP54
Recessed type

Hazardous areas, Zone 2, Ex "nA" Non sparking
 Body : Electrolytic Galvanized Iron steel sheet deep drawn
 Diffuser : Milky polycarbonate
 Cable entry : 4 Cable glands

Model no.	Capacity	L(mm)	W(mm)	H(mm)	Weight(kg)	Remarks
FX-220nA-C	18Wx2	667	275	125	10.60	G13
FX-420nA-C	36Wx2	1270	275	125	17.40	G13

• Optional : Battery back up to 180 min.

Temperature Classes

Temperature Class	Highest permissible surface temperature of the equipment	Ignition temperatures of the combustible substances
T1	450°C	> 450°C
T2	300°C	> 300°C
T3	200°C	> 200°C
T4	135°C	> 135°C
T5	100°C	> 100°C
T6	85°C	> 85°C

**PX-H50nR**

Ex-nR II T2

HALOGEN FLOOD LIGHT IP67
Sodium flood light

Hazardous areas, Zone 2, Ex "nR" Restricted Breathing Enclosure
 Body : Stainless steel sheet deep drawn
 Front glass : Clear tempered glass
 Reflector : High polished aluminium anodized (narrow beam)
 Cable entry : 2 Cable glands

Model no.	Capacity	L(mm)	W(mm)	H(mm)	Weight(kg)	Remarks
PX-H50nR	500W	444	181	398	6.35	E39/E40
PX-S40nR	400W	444	181	398	6.25	E39/E40

**PX-S42nR**

Ex-nR II T2

H.P.SODIUM FLOOD LIGHT IP67

Hazardous areas, Zone 2, Ex "nR" Restricted Breathing Enclosure
 Body : Stainless steel sheet deep drawn
 Front glass : Clear tempered glass
 Reflector : High polished aluminium anodized (narrow beam)
 Cable entry : 2 Cable glands

Model no.	Capacity	L(mm)	W(mm)	H(mm)	Weight(kg)	Remarks
PX-S42nR	400Wx2	444	181	520	13.2	E39/E40

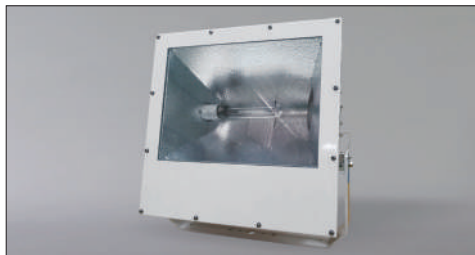
**PX-S(H)*nR**

Ex-nR IIC T3

FLOOD LIGHT IP67
H.P.Sodium / Halogen

Hazardous areas, Zone 2, Ex "nR" Restricted Breathing Enclosure
 Body : Stainless steel sheet deep drawn
 Front glass : Clear tempered glass
 Reflector : High polished aluminium anodized (narrow beam)
 Cable entry : 2 Cable glands

Model no.	Capacity	L(mm)	W(mm)	H(mm)	Weight(kg)	Remarks
PX-S40nR	400Wx1	583	240	660	29.8	H.P. Sodium
PX-S60nR	600Wx1	583	240	660	29.8	H.P. Sodium
PX-H50nR	500Wx1	583	240	660	24.8	H.P. Sodium

**BX-S42nR**

Ex-nR II T4

BALLAST BOX IP67

Hazardous areas, Zone 2, Ex "nR" Restricted Breathing Enclosure
 Body & cover : Electrolytic zinc galvanized steel
 or Stainless steel sheet deep drawn
 Triple Cable entry : 3 Cable glands

Model no.	Capacity	L(mm)	W(mm)	H(mm)	Weight(kg)	Remarks
BX-S40nR	1x400W	234	444	136	12.4	
BX-S42nR	2x400W	234	444	136	19.7	

**SX-21d**

Ex-d IIC T6

FRAME PROOF SWITCH IP66

Hazardous areas, Zone 1 and 2, Ex "d" Flameproof enclosure
 Body & cover : Cast brass
 Cable entry : 2 Cable glands
 Voltage : AC250V

Model no.	Capacity	L(mm)	W(mm)	H(mm)	Weight(kg)	Remarks
SX-21d	16A	100	92.5	76	1.7	DPST

**SRK-S**

Non Hazardous areas
 Body & cover : Cast brass
 Cable entry : 2 Cable glands
 Voltage : AC250V
 Shape of type "A" standard

CONTROL KEY SWITCH IP56

Model no.	Capacity	L(mm)	W(mm)	H(mm)	Weight(kg)	Remarks
SRK-S	16A	124	143	100	2.8	DPST

• Optional : Shape of key "B" "C" "D" "E" "F"

**JBX**

Ex-d IIC T6

EXPLOSION PROOF JUNCTION BOX IP66

Hazardous areas, Zone 1 and 2, Ex "d" Flameproof enclosure
 Body & cover : Cast brass
 Cable entry : 2 or 4 Cable glands
 Voltage : AC250V

Model no.	Capacity	L(mm)	W(mm)	H(mm)	Weight(kg)	Remarks
JBX-4d95	20A	143	129	66	2.67	4Gland 4P
JBX-4d125	30A	173	159	70	3.75	4Gland 4P

**CBX**

Ex-e II T6

CONNECTION BOX IP66

Increased safety

Hazardous areas, Zone 1 and 2, Ex "e" Increased safety
 Body & cover : Stainless steel plate
 With hinge door and gland plate

Model no.	Capacity	L(mm)	W(mm)	H(mm)	Weight(kg)	Remarks
CBX-B11eP	20A	260	260	260	9.6	
CBX-B12eP	20A	260	260	380	10.2	
CBX-B13eP	20A	350	350	500	15.7	



**WIRING DEVICE
FOR LIGHTING FIXTURES**

**RTS-D31W****RECEPTACLE W/SWITCH IP56**
Din type

Machinery area, outdoor use
 Body : Cast brass / Polycarbonate
 Cover & blind cover : Polycarbonate
 Cable entry : 2 Cable glands
 Voltage : AC250V 2pole+1E

Model no.	Capacity	L(mm)	W(mm)	H(mm)	Weight(kg)	Remarks
RTS-D31W-P	16A	146	113	114	0.57	Polycarbonate
RTS-D31W-B	16A	146	113	114	1.57	Cast brass

**RT-D31W****RECEPTACLE IP56**
Din type

Machinery area, outdoor use
 Body : Cast brass / Polycarbonate
 Cover & blind cover : Polycarbonate
 Cable entry : 2 Cable glands
 Voltage : AC250V 2pole+1E

Model no.	Capacity	L(mm)	W(mm)	H(mm)	Weight(kg)	Remarks
RT-D31W-P	16A	146	113	79	0.40	Polycarbonate
RT-D31W-B	16A	146	113	79	1.49	Cast brass

**RTS-D32W****RECEPTACLE W/SWITCH IP56**
Din type, 2-gang

Machinery area, outdoor use
 Body & cover : Cast brass
 Blind cover : Polycarbonate
 Cable entry : 2 Cable glands
 Voltage : AC250V 2pole+1E

Model no.	Capacity	L(mm)	W(mm)	H(mm)	Weight(kg)	Remarks
RTS-D32W-B	16A	200	144	78	2.32	

**RT-D32W****RECEPTACLE IP56**
Din type, 2-gang

Machinery area, outdoor use
 Body & cover : Cast brass
 Blind cover : Polycarbonate
 Cable entry : 2 Cable glands
 Voltage : AC250V 2pole+1E

Model no.	Capacity	L(mm)	W(mm)	H(mm)	Weight(kg)	Remarks
RTS-D32W-B	16A	200	144	78	2.22	

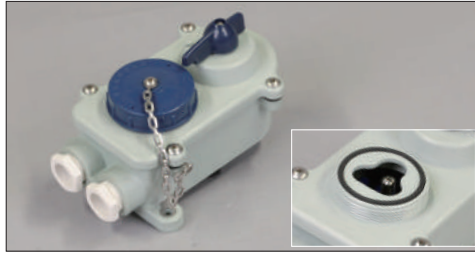
**RTS-J31W****RECEPTACLE W/SWITCH IP56**
Old-JIS type

Machinery area, outdoor use
 Body & cover : Cast brass / PBT (Poly Butylene Terephthalate)
 Blind cover : Cast brass / Polycarbonate
 Cable entry : 2 Cable glands
 Voltage : AC250V 2pole+1E

Model no.	Capacity	L (mm)	W (mm)	H (mm)	Weight (kg)	Remarks
RTS-J31W-P	15A	190	120	95	0.85	PBT
RTS-J31W-B	15A	190	120	95	2.10	Cast brass

**RT-J31W****RECEPTACLE IP56**
Old-JIS type

Machinery area, outdoor use
 Body & cover : Cast brass / PBT (Poly Butylene Terephthalate)
 Blind cover : Cast brass / Polycarbonate
 Cable entry : 2 Cable glands
 Voltage : AC250V 2pole+1E

Model no.	Capacity	L(mm)	W(mm)	H(mm)	Weight(kg)	Remarks
RT-J31W-P	15A	127	120	77	0.40	PBT
RT-J31W-B	15A	127	120	77	1.24	Cast brass

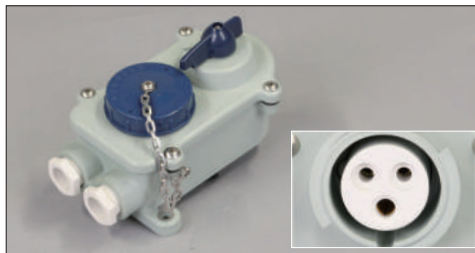
**RTS1-J31W****RECEPTACLE W/SWITCH IP56**
New-JIS type

Machinery area, outdoor use
 Body & cover : PBT (Poly Butylene Terephthalate)
 Blind cover : Polycarbonate
 Cable entry : 2 Cable glands
 Voltage : AC250V 2pole+1E

Model no.	Capacity	L(mm)	W(mm)	H(mm)	Weight(kg)	Remarks
RTS1-J31W-P	16A	190	120	95	0.85	PBT

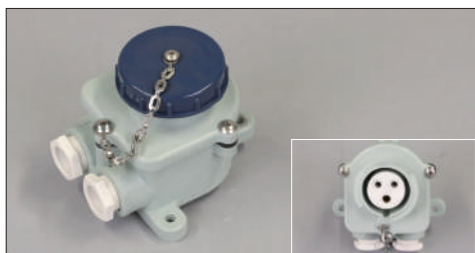
**RT1-J31W****RECEPTACLE IP56**
New-JIS type

Machinery area, outdoor use
 Body & cover : PBT (Poly Butylene Terephthalate)
 Blind cover : Polycarbonate
 Cable entry : 2 Cable glands
 Voltage : AC250V 2pole+1E

Model no.	Capacity	L(mm)	W(mm)	H(mm)	Weight(kg)	Remarks
RT1-J31W-P	16A	127	120	77	0.40	PBT

**SR-SIW-D****SWITCH (DPST, DPDT) IP56**

Machinery area, outdoor use
 Body : Cast brass
 Cover & handle : Polycarbonate
 Cable entry : 2 Cable glands
 Voltage : AC250V 2pole

Model no.	Capacity	L (mm)	W (mm)	H (mm)	Weight (kg)	Remarks
SR-S1W21B-D	16A	116	112	74	1.10	DPST
SR-S1W22B-D	16A	116	112	92	1.20	DPDT

• Optional : Red handle, Brass cover

**SR-SIW-J****SWITCH (DPST, DPDT) IP56**

Machinery area, outdoor use
 Body & cover : PBT (Poly Butylene Terephthalate)
 Handle : Polycarbonate
 Cable entry : 2 Cable glands
 Voltage : AC250V 2pole

Model no.	Capacity	L(mm)	W(mm)	H(mm)	Weight(kg)	Remarks
SR-S1W21P-J	16A	128	116	96	0.38	DPST
SR-S1W22P-J	16A	128	116	96	0.38	DPDT

**SRL-SIW-J****SWITCH WITH INDICATOR LAMP IP56**

Machinery area, outdoor use
 Body & cover : Cast brass / PBT (Poly Butylene Terephthalate)
 Handle & lamp cap : Cast brass / Polycarbonate
 Cable entry : 2Cable glands
 Voltage : AC250V 2pole

Model no.	Capacity	L(mm)	W(mm)	H(mm)	Weight(kg)	Remarks
SRL-S1W21P-J	16A, 5W bulb	190	117	126	0.45	PBT
SRL-S1W21B-J	16A, 5W bulb	190	117	126	2.07	Cast brass

**RTDS-SW****DC RECEPTACLE IP56**

For Daylight signalling lamp

Machinery area, daylight signalling lamp
 Body & cover : Cast brass
 Receptacle cover : Cast brass
 Cable entry : 2Cable glands
 Voltage : DC24V

Model no.	Capacity	L(mm)	W(mm)	H(mm)	Weight(kg)	Remarks
RTDS-SW	5A	116	136	70	1.10	4P connector

**PG-D3W****PLUG (2P+1E) IP56**
Din type

Machinery area, outdoor use
 Body : Cast brass / Polycarbonate
 Cover : Cast brass / Polycarbonate
 Cable entry : 1 Cable gland
 Voltage : AC250V

Model no.	Capacity	L (mm)	W (mm)	H (mm)	Weight (kg)	Remarks
PG-D3W2B	16A	95	58	58	0.60	Brass
PG-D3W2P	16A	137	65	65	0.40	PC

**PG-J3W****PLUG (2P+1E) IP56**
Old-JIS type

Machinery area, outdoor use
 Body : Cast brass
 Cover : Cast brass
 Cable entry : 1 Cable gland
 Voltage : AC250V

Model no.	Capacity	L (mm)	W (mm)	H (mm)	Weight (kg)	Remarks
PG-J3W2B	15A	95	58	58	0.60	Brass
PG-J3W2P	15A	137	65	65	0.40	PC

**PG-J3W2PL****PLUG (2P+1E) L-TYPE IP56**
Old-JIS type

Machinery area, outdoor use
 Body : ABS (Acrylonitrile Butadiene Styrene)
 Cover : ABS (Acrylonitrile Butadiene Styrene)
 Cable entry : 1 Cable gland
 Voltage : AC250V

Model no.	Capacity	L(mm)	W(mm)	H(mm)	Weight(kg)	Remarks
PG-J3W2PL	15A	92	87	92	0.13	

**PG1-J3W2PL****PLUG (2P+1E) L-TYPE IP56**
New-JIS type

Machinery area, outdoor use
 Body : ABS (Acrylonitrile Butadiene Styrene)
 Cover : ABS (Acrylonitrile Butadiene Styrene)
 Cable entry : 1 Cable gland
 Voltage : AC250V

Model no.	Capacity	L(mm)	W(mm)	H(mm)	Weight(kg)	Remarks
PG1-J3W2PL	16A	75	60	60	0.40	

**JBW-*RB****JUNCTION BOX ROUND TYPE IP56**

Machinery area, outdoor use
 Body : Cast brass
 Cover : Cast brass
 Cable entry : 2 or 4 Cable glands
 Voltage : AC250V

Model no.	Capacity	L (mm)	W (mm)	H (mm)	Weight (kg)	Remarks
JBW-44RBN	20A	136	118	49	0.95	4 Glands, 4P
JBW-24RBN	20A	116	118	49	0.80	2 Glands, 4P

**JB-4d125B****JUNCTION BOX ROUND TYPE IP56**

Machinery area, outdoor use
 Body : Cast brass
 Cover : Cast brass
 Cable entry : 2 or 4 Cable glands
 Voltage : AC250V

Model no.	Capacity	L(mm)	W(mm)	H(mm)	Weight(kg)	Remarks
JB-4d125B	20A	125	125	80	3.75	4 Glands, 4P

**JBW-46QP****JUNCTION BOX SQUARE TYPE IP56**

Machinery area, outdoor use
 Body : PBT (Poly Butylene Terephthalate)
 Cover : PBT (Poly Butylene Terephthalate)
 Cable entry : 4 Cable glands
 Voltage : AC250V

Model no.	Capacity	L(mm)	W(mm)	H(mm)	Weight(kg)	Remarks
JBW-46QP	20A	136	118	49	0.48	4 Glands, 6P
JBW-66QP	20A	136	118	49	0.5	6 Glands, 6P

**JBW-24QP****JUNCTION BOX SQUARE TYPE IP56**

Machinery area, outdoor use
 Body : PBT (Poly Butylene Terephthalate)
 Cover : PBT (Poly Butylene Terephthalate)
 Cable entry : 2 Cable glands
 Voltage : AC250V

Model no.	Capacity	L(mm)	W(mm)	H(mm)	Weight(kg)	Remarks
JBW-24QP	20A	116	118	49	0.80	2Grands, 4P

WIRING DEVICE FOR LIGHTING FIXTURES



RTWD-32 **RECEPTACLE W/SWITCH (3P+1E) IP56**
for Arc welding

Arc welding
Body & cover : Cast brass
Blind cover : Cast brass
Cable entry : 1 or 2 Cable gland
Voltage : AC440V

Model no.	Capacity	L (mm)	W (mm)	H (mm)	Weight (kg)	Remarks
RTWD-321	32A	225	150	131	5.80	1 Gland
RTWD-322	32A	225	150	131	5.80	2 Gland



PG-D4W5B **PLUG (3P+1E) IP56**

Arc welding
Body & cover : Cast brass
Blind cover : Cast brass
Cable entry : 1 or 2 Cable gland
Voltage : AC440V

Model no.	Capacity	L (mm)	W (mm)	H (mm)	Weight (kg)	Remarks
PG-D4W5B	32A	56	56	195	1.50	

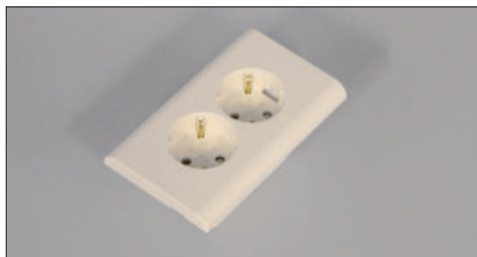

RT45-D32NF **RECEPTACLE FLUSH IP20**
Din (2P+1E), 2-gang

Accommodation areas
Body : ABS (Acrylonitrile Butadiene Styrene)
Voltage : AC250V

Model no.	Capacity	L(mm)	W(mm)	H(mm)	Weight(kg)	Remarks
RT45-D32NF-P	16A	75	123	55	0.10	

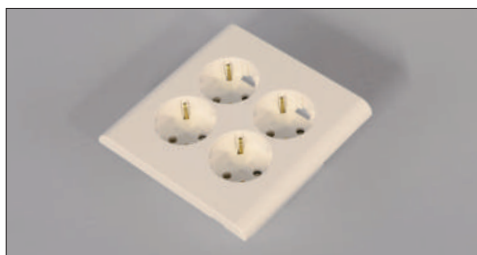

RT45-D34NF **RECEPTACLE FLUSH IP20**
Din (2P+1E), 4-gang

Accommodation areas
Body : ABS (Acrylonitrile Butadiene Styrene)
Voltage : AC250V

Model no.	Capacity	L(mm)	W(mm)	H(mm)	Weight(kg)	Remarks
RT45-D34NF-P	16A	123	122	55	0.18	

**RT-D31NF-P****RECEPTACLE SIGLE FLUSH IP20**
Din(2P+1E)

Accommodation areas
 Body : ABS (Acrylonitrile Butadiene Styrene)
 Voltage : AC250V

Model no.	Capacity	L (mm)	W (mm)	H (mm)	Weight (kg)	Remarks
RT-D31NF-P	16A	84	84	42	0.10	

**RT-D32NF-P****RECEPTACLE DOUBLE FLUSH IP20**
Din(2P+1E)

Accommodation areas
 Body : ABS (Acrylonitrile Butadiene Styrene)
 Voltage : AC250V

Model no.	Capacity	L(mm)	W(mm)	H(mm)	Weight(kg)	Remarks
RT-D32NF-P	16A	103	84	42	0.14	

**RT-D31N-P****RECEPTACLE SIGLE SURFACE IP20**
Din(2P+1E)

Accommodation areas
 Body : ABS (Acrylonitrile Butadiene Styrene)
 Voltage : AC250V

Model no.	Capacity	L(mm)	W(mm)	H(mm)	Weight(kg)	Remarks
RT-D31N-P	16A	63	71	42	0.10	

**RT-D32N-P****RECEPTACLE DOUBLE SURFACE IP20**
Din(2P+1E)

Accommodation areas
 Body : ABS (Acrylonitrile Butadiene Styrene)
 Voltage : AC250V

Model no.	Capacity	L(mm)	W(mm)	H(mm)	Weight(kg)	Remarks
RT-D32N-P	16A	104	71	42	0.15	

**RT-D31SF-P****RECEPTACLE SINGLE FLUSH IP44**
Din(2P+1E)Accommodation areas
Body : ABS (Acrylonitrile Butadiene Styrene)
Voltage : AC250V

Model no.	Capacity	L (mm)	W (mm)	H (mm)	Weight (kg)	Remarks
RT-D31SF-P	16A	84	84	42	0.17	

**RT-D32SF-P****RECEPTACLE DOUBLE FLUSH IP44**
Din(2P+1E)Accommodation areas
Body : ABS (Acrylonitrile Butadiene Styrene)
Voltage : AC250V

Model no.	Capacity	L (mm)	W (mm)	H (mm)	Weight (kg)	Remarks
RT-D32SF-P	16A	85	111	52	0.22	

**RT-D31S-P****RECEPTACLE SINGLE SURFACE IP44**
Din(2P+1E)Accommodation areas
Body : ABS (Acrylonitrile Butadiene Styrene)
Voltage : AC250V

Model no.	Capacity	L(mm)	W(mm)	H(mm)	Weight(kg)	Remarks
RT-D31S-P	16A	75	68	55	0.10	

**RT-D32S-P****RECEPTACLE DOUBLE SURFACE IP44**
Din(2P+1E)Accommodation areas
Body : ABS (Acrylonitrile Butadiene Styrene)
Voltage : AC250V

Model no.	Capacity	L(mm)	W(mm)	H(mm)	Weight(kg)	Remarks
RT-D32S-P	16A	75	100	50	0.25	

**RTDS-FN****DC RECEPTACLE FLUSH IP20**
For Daylight signalling lamp

Accommodation areas
 Body & cover : ABS (Acrylonitrile Butadiene Styrene)
 Receptacle cover : Cast brass
 Voltage : DC24V

Model no.	Capacity	L (mm)	W (mm)	H (mm)	Weight (kg)	Remarks
RTDS-FN	5A	80	116	62	0.11	4P connector

**ST-F1N*P****SWITCH SIGLE FLUSH IP20**
Din type (DPST, DPDT)

Accommodation areas
 Body & cover : ABS (Acrylonitrile Butadiene Styrene)
 Voltage : AC250V

Model no.	Capacity	L(mm)	W(mm)	H(mm)	Weight(kg)	Remarks
ST-F1N21P	16A	84	84	28.5	0.10	DPST
ST-F1N22P	16A	84	84	28.5	0.10	DPDT

**ST-F2N*P****SWITCH DOUBLE FLUSH IP20**
Din type (DPST, DPDT)

Accommodation areas
 Body & cover : ABS (Acrylonitrile Butadiene Styrene)
 Voltage : AC250V

Model no.	Capacity	L(mm)	W(mm)	H(mm)	Weight(kg)	Remarks
ST-F2N21P	16A	84	156	28.5	0.14	DPST
ST-F2N22P	16A	84	156	28.5	0.14	DPDT

**ST-S1N*P****SWITCH SINGLE SURFACE IP20**
Din type (DPST, DPDT)

Accommodation areas
 Body & cover : ABS (Acrylonitrile Butadiene Styrene)
 Voltage : AC250V

Model no.	Capacity	L(mm)	W(mm)	H(mm)	Weight(kg)	Remarks
ST-S1N21P	16A	84	71	28.5	0.10	DPST
ST-S1N22P	16A	84	71	28.5	0.10	DPDT

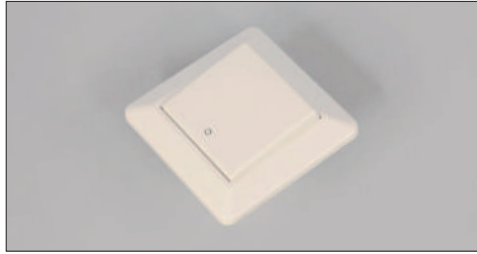
**ST-F1S*P****SWITCH SINGLE FLUSH IP44**
Din type (DPST, DPDT)Accommodation areas
Body : ABS (Acrylonitrile Butadiene Styrene)
Voltage : AC250V

Model no.	Capacity	L (mm)	W (mm)	H (mm)	Weight (kg)	Remarks
ST-F1S21P	16A	84	84	29	0.10	DPST
ST-F1S22P	16A	84	84	29	0.10	DPDT

**ST-S1S*P****SWITCH SINGLE SURFACE IP44**
Din type (DPST, DPDT)Accommodation areas
Body : ABS (Acrylonitrile Butadiene Styrene)
Voltage : AC250V

Model no.	Capacity	L (mm)	W (mm)	H (mm)	Weight (kg)	Remarks
ST-S1S21P	16A	87	68	37	0.15	DPST
ST-S1S22P	16A	87	68	37	0.15	DPDT

**SD-I50F****DIMMER SWITCH FLUSH TYPE IP20**
For Incandescent lightAccommodation areas
Body : ABS (Acrylonitrile Butadiene Styrene)
Voltage : AC250V

Model no.	Capacity	L(mm)	W(mm)	H(mm)	Weight(kg)	Remarks
SD-I50F	500VA	71	120	20	0.25	Flush

**SD-LE15F****DIMMER SWITCH FLUSH TYPE IP20**
For fluorescent lamp & LED lampAccommodation areas
Body : ABS (Acrylonitrile Butadiene Styrene)
Voltage : AC250V

Model no.	Capacity	L(mm)	W(mm)	H(mm)	Weight(kg)	Remarks
SD-LE15F	6A	90	90	12	0.1	Flush

**PG-D3N2P****PLUG (2P+1E) IP20**
Din typeAccommodation areas
Body : ABS (Acrylonitrile Butadiene Styrene)
Voltage : AC250V

Model no.	Capacity	L (mm)	W (mm)	H (mm)	Weight (kg)	Remarks
PG-D3N2P	16A	37	37	69	0.03	

**PG-DS****DC PLUG IP20**
For Daylight signalling lampAccommodation areas
Body : Cast brass
Voltage : DC24V

Model no.	Capacity	L(mm)	W(mm)	H(mm)	Weight(kg)	Remarks
PG-DS	5A	28	28	50	0.05	4P connector

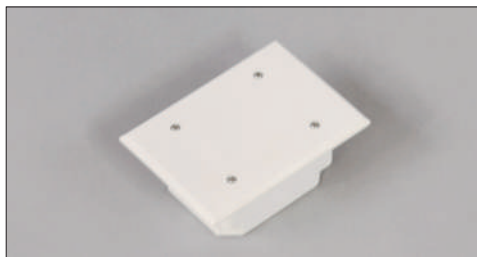
**JBN-FP****JUNCTION BOX FLUSH TYPE IP20**
Square typeAccommodation areas
Body : ABS (Acrylonitrile Butadiene Styrene)
Voltage : AC250V

Model no.	Capacity	L(mm)	W(mm)	H(mm)	Weight(kg)	Remarks
JBN-04FP	20A	81	115	48	0.20	4P

**JBN-RP****JUNCTION BOX FLUSH TYPE IP20**
Round typeAccommodation areas
Body : ABS (Acrylonitrile Butadiene Styrene)
Voltage : AC250V

Model no.	Capacity	L(mm)	W(mm)	H(mm)	Weight(kg)	Remarks
JBN-04RP	20A	80	80	48	0.20	4P



**LED
LIGHTING FIXTURE
FOR NAVAL VESSEL**

LED LIGHTING FIXTURE FOR NAVAL VESSEL



N/LE152NF

LED NWT CEILING LIGHT 2C IP44
Flush type

Galley, store, accommodation areas
Body : Aluminium plate
Diffuser : Polycarbonate
LED : 0.2W LED Package
Cable entry : 2 cable glands

Model no.	Capacity	L (mm)	W (mm)	H (mm)	Weight (kg)	Remarks
N/LE152NF	25W	740	227	127	5.0	FL20Wx2



N/LE153NF

LED NWT CEILING LIGHT 3C IP44
Flush type

Galley, store, accommodation areas
Body : Aluminium plate
Diffuser : Opal acrylic
LED : 0.2W LED Package
Cable entry : 2 cable glands

Model no.	Capacity	L(mm)	W(mm)	H(mm)	Weight(kg)	Remarks
N/LE153NF	30W	740	227	127	5.0	FL20Wx3



N/LE153NF

LED NWT CEILING LIGHT 3C IP44
Flush type (white X2, redX1)

-W/2, R/1
Galley, store, accommodation areas
Body : Aluminium plate
Diffuser : Opal acrylic
LED : 0.2W LED Package
Cable entry : 4 cable glands

Model no.	Capacity	L(mm)	W(mm)	H(mm)	Weight(kg)	Remarks
N/LE153NF-W/2, R/1	25W,5W	740	227	127	5.0	FL20Wx3



N/LE152WV

LED WT CEILING LIGHT 2C IP56

Galley, store, accommodation areas
Body : Aluminium
Diffuser : Polycarbonate
LED : 0.2W LED Package
Cable entry : 2 or 4 cable glands

Model no.	Capacity	L(mm)	W(mm)	H(mm)	Weight(kg)	Remarks
N/LE152WV	30W	733	190	127	5.15	FL20Wx2

LED LIGHTING FIXTURE FOR NAVAL VESSEL

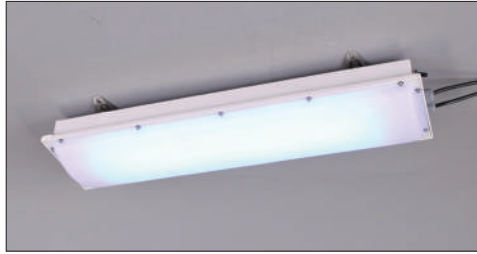

N/LE152WV-S LED WT CEILING LIGHT 2C IP56
With switch

Engine room, store, accommodation areas
 Body : Aluminium
 Diffuser : milky polycarbonate
 LED : 0.2W LED Package
 Cable entry : 2 or 4 cable glands

Model no.	Capacity	L (mm)	W (mm)	H (mm)	Weight (kg)	Remarks
N/LE152WV-S	30W	733	190	127	5.15	FL20Wx2



N/LE153WV LED WT CEILING LIGHT 3C IP56

Engine room, store, accommodation areas
 Body : Aluminium
 Diffuser : milky polycarbonate
 LED : 0.2W LED Package
 Cable entry : 2 or 4 cable glands

Model no.	Capacity	L(mm)	W(mm)	H(mm)	Weight(kg)	Remarks
N/LE153WV	40W	733	190	127	5.15	FL20Wx3

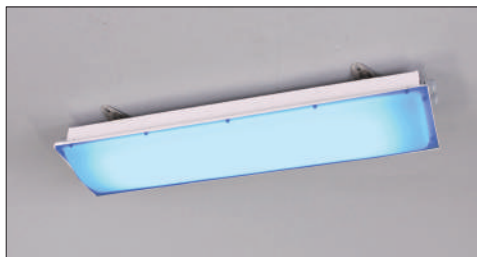

N/LE153WV LED WT CEILING LIGHT 3C IP56
-W/2, R/1(B/1) white x 2, red(blue) x 1

Engine room, store, accommodation areas
 Body : Aluminium
 Diffuser : milky polycarbonate
 LED : 0.2W LED Package
 Cable entry : 2 or 4 cable glands

Model no.	Capacity	L(mm)	W(mm)	H(mm)	Weight(kg)	Remarks
N/LE153WV-W/2, R/1	30W,5W	733	190	127	5.15	FL20Wx3
N/LE153WV-W/2, B/1	30W,5W	733	190	127	5.15	FL20WX3

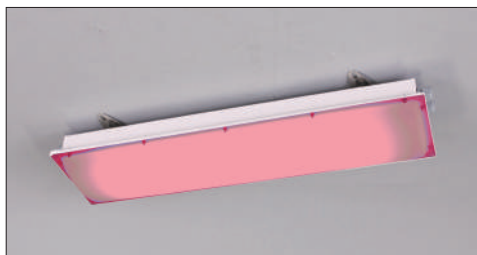

N/LE153WV-S LED WT CEILING LIGHT 3C IP56
-R/3 Red x 3

Engine room, store, accommodation areas
 Body : Aluminium
 Diffuser : milky polycarbonate
 LED : 0.2W LED Package
 Cable entry : 2 or 4 cable glands

Model no.	Capacity	L(mm)	W(mm)	H(mm)	Weight(kg)	Remarks
N/LE153WV-R/3	15W	733	190	127	5.15	FL20Wx3

LED LIGHTING FIXTURE FOR NAVAL VESSEL



N/LED04NS

LED DESK LIGHT IP20
With switch

Accommodation areas, desk wall
Body : Aluminium
LED : 0.2W LED Package
Cable entry : 2 cable clamps

Model no.	Capacity	L (mm)	W (mm)	H (mm)	Weight (kg)	Remarks
N/LED04NS	4W	690	182	56	2.0	

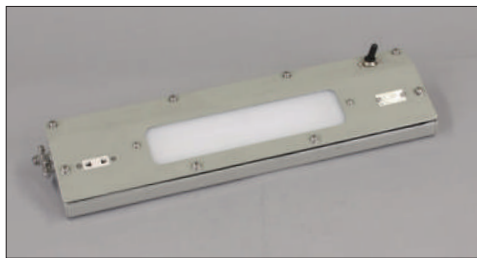

N/LEB07NW

LED BED LIGHT IP20
With switch & receptacle

Accommodation areas, desk wall
Body : Aluminium
Diffuser : milky polycarbonate
LED : 0.2W LED Package
Cable entry : 2 cable clamps

Model no.	Capacity	L(mm)	W(mm)	H(mm)	Weight(kg)	Remarks
N/LEB07NW	7W	420	103	35	1.4	



N/LEM09SS

LED MIRROR LIGHT IP44
With switch

Shower rooms, wash rooms, toilets
Body : Aluminium plate
Diffuser : milky polycarbonate
LED : 0.2W LED Package
Cable entry : 2 cable glands

Model no.	Capacity	L(mm)	W(mm)	H(mm)	Weight(kg)	Remarks
N/LEM09SS	9W	550	94	94	2.1	



N/LEM09SR

LED MIRROR LIGHT IP44
With switch & receptacle

Shower rooms, wash rooms, toilets
Body : Aluminium plate (AL5052)
Diffuser : milky acryl
LED : 0.2W LED Package
Cable entry : 2 cable glands

Model no.	Capacity	L(mm)	W(mm)	H(mm)	Weight(kg)	Remarks
N/LEM09SR	9W	681	94	94	2.6	w/receptacle

LED LIGHTING FIXTURE FOR NAVAL VESSEL

**N/LEP08-M****LED PENDANT LIGHT IP56**
Milky globe

Engine room, store, accommodation areas
 Body : Brass plate & Cast brass
 Globe : Milky glass
 LED : Bulb type
 Cable entry : 2 cable glands

Model no.	Capacity	L (mm)	W (mm)	H (mm)	Weight (kg)	Remarks
N/LEP08-M	7.2W	134	134	240	2.2	

**N/LEP08-MS****LED PENDANT LIGHT w/switch IP56**
Milky globe

Engine room, store, accommodation areas
 Body : Brass plate & Cast brass
 Globe : Milky glass
 LED : Bulb type
 Cable entry : 2 cable glands

Model no.	Capacity	L(mm)	W(mm)	H(mm)	Weight(kg)	Remarks
N/LEP08-MS	7.2W	134	134	240	2.3	

**N/LEP08-C****LED PENDANT LIGHT IP56**
Clear globe

Engine room, store, accommodation areas
 Body : Brass plate & Cast brass
 Globe : Clear glass
 LED : Bulb type
 Cable entry : 2 cable glands

Model no.	Capacity	L(mm)	W(mm)	H(mm)	Weight(kg)	Remarks
N/LEP08-C	7.2W	134	134	240	2.3	

**N/LEP08-W/G****LED PENDANT LIGHT w/guard IP56**
Clear globe

Engine room, store, accommodation areas
 Body & Guard : Brass plate & Cast brass
 Globe : Clear glass
 LED : Bulb type
 Cable entry : 2 cable glands

Model no.	Capacity	L (mm)	W (mm)	H (mm)	Weight (kg)	Remarks
N/LEP08-W/G	7.2W	134	134	255	2.6	

LED LIGHTING FIXTURE FOR NAVAL VESSEL



N/LEP08-RS LED RED PENDANT LIGHT w/switch IP56
Red globe

Engine room, store, accommodation areas
 Body : Brass plate & Cast brass
 Globe : Red glass
 LED : Bulb type
 Cable entry : 2 cable glands

Model no.	Capacity	L(mm)	W(mm)	H(mm)	Weight(kg)	Remarks
N/LEP08-RS	7.2W	134	134	240	2.3	



N/LEB03-RS LED RED BRACKET LIGHT w/switch IP56
Red globe

Engine room, store, accommodation areas
 Body : Brass plate & Cast brass
 Globe : Red glass
 LED : Bulb type
 Cable entry : 2 cable glands

Model no.	Capacity	L(mm)	W(mm)	H(mm)	Weight(kg)	Remarks
N/LEB03-RS	3W	151	142	178	1.2	w/receptacle



N/LETS03 LED CHART TABLE LIGHT IP20
With dimming switch

Body : Aluminium plate
 Filter : Red polycarbonate
 LED : 0.2W LED Package
 Cable entry : 1 cable clamp

Model no.	Capacity	L (mm)	W (mm)	H (mm)	Weight (kg)	Remarks
N/LETS03	3W	300	300	400	0.92	



N/LES03 LED SPOT LIGHT IP56

Body : Aluminium plate
 Filter : Red polycarbonate
 Toggle switch : AC 250v 2pole 6A
 LED : 0.2W LED Package
 Cable entry : 1 cable clamp

Model no.	Capacity	L(mm)	W(mm)	H(mm)	Weight(kg)	Remarks
N/LES03	3W	133	121	137	0.8	

LED LIGHTING FIXTURE FOR NAVAL VESSEL

**N/LES00****SURGICAL LIGHT IP56**

Body : Brass plate & Cast brass
 Globe : Opal polycarbonate
 Lamp & Holder : AC 120/220V, 3W x 1ea, E27
 Cable entry : Cable & plug

Model no.	Capacity	L (mm)	W (mm)	H (mm)	Weight (kg)	Remarks
N/LES00	3W	462	462	381	7.8	

**N/LEN08****HULL NUMERALS LIGHT IP56**

Body : Brass plate & Cast brass
 Globe : Clear glass
 LED : 7.2W bulb type
 Cable entry : Cable & plug

Model no.	Capacity	L(mm)	W(mm)	H(mm)	Weight(kg)	Remarks
N/LEN08	7.2W	260	180	955	5.3	

**N/LE02-B****LED RELAY LANTERN IP56**

Accommodation areas, passage, store
 Body : PFG
 Front glass : clear glass
 LED : 0.2W LED Package
 Cable entry : 1 cable gland

Model no.	Capacity	L(mm)	W(mm)	H(mm)	Weight(kg)	Remarks
N/LE02-B	1.8W	167	155	220	3.4	

**N/LE02-BR****LED HAND LANTERN IP56**

With cord & plug

Accommodation areas, passage, store
 Body : PFG
 Front glass : clear glass
 LED : 0.2W LED Package
 Cable entry : 1 cable gland w/cord & WT plug

Model no.	Capacity	L(mm)	W(mm)	H(mm)	Weight(kg)	Remarks
N/LE02-BR	1.8W	167	154	171	3.4	

LED LIGHTING FIXTURE FOR NAVAL VESSEL

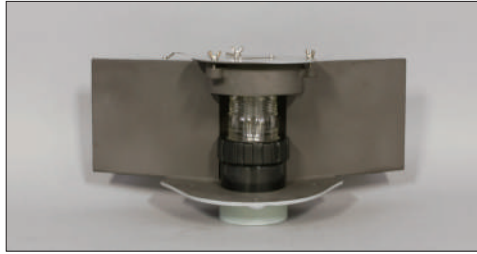

N/LEML06

MASTHEAD LIGHT IP56
White

Navigation light 225°, 6N.miles
Body : PFG & Aluminium plate
Globe : Clear glass
LED : 1W LED package
Cable entry : 1 cable gland

Model no.	Capacity	L (mm)	W (mm)	H (mm)	Weight (kg)	Remarks
N/LEML06	6W	560	560	235	4.37	

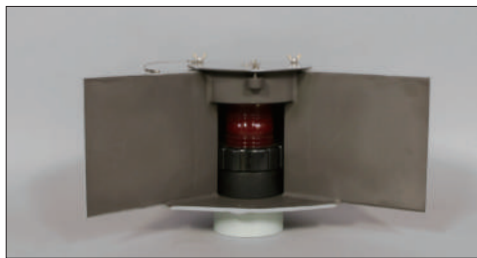

N/LEPL06

PORT SIDE LIGHT IP56
Red

Navigation light 112.5°, 3N.miles
Body : PFG & Aluminium plate
Globe : Red glass
LED : 1W LED package
Cable entry : 1 cable gland

Model no.	Capacity	L(mm)	W(mm)	H(mm)	Weight(kg)	Remarks
N/LEPL06	6W	500	500	235	4.35	

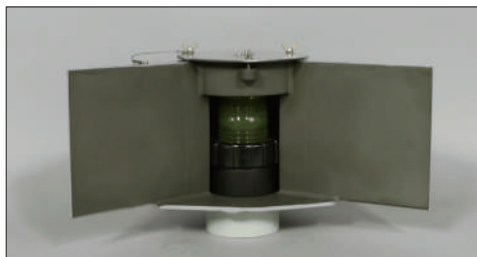

N/LETL06

STARBOARD SIDE LIGHT IP56
Green

Navigation light 112.5°, 3N.miles
Body : PFG & Aluminium plate
Globe : Green glass
LED : 1W LED package
Cable entry : 1 cable gland

Model no.	Capacity	L(mm)	W(mm)	H(mm)	Weight(kg)	Remarks
N/LETL06	6W	500	500	235	4.35	



N/LESL06

STERN LIGHT IP56
White

Navigation light 135°, 3N.miles
Body : PFG & Aluminium plate
Globe : Clear glass
LED : 1W LED package
Cable entry : 1 cable gland

Model no.	Capacity	L(mm)	W(mm)	H(mm)	Weight(kg)	Remarks
N/LESL06	6W	560	560	235	4.37	

LED LIGHTING FIXTURE FOR NAVAL VESSEL

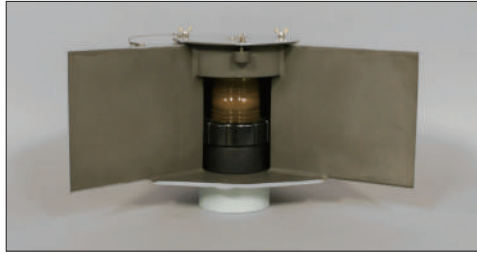
**N/LESL06-Y****STERN TOWING LIGHT IP56**
Yellow

Navigation light 135°, 3N.miles
 Body : PFG & Aluminium plate
 Globe : Yellow glass
 LED : 1W LED package
 Cable entry : 1 cable gland

Model no.	Capacity	L (mm)	W (mm)	H (mm)	Weight (kg)	Remarks
N/LESL06-Y	6W	560	560	235	4.37	

**N/LEAL06****ANCHOR LIGHT IP56**
White

Anchor light 360°, 3N.miles
 Body : PFG
 Globe : Clear glass
 LED : 1W LED package
 Cable entry : 1 cable gland

Model no.	Capacity	L(mm)	W(mm)	H(mm)	Weight(kg)	Remarks
N/LEAL06	6W	150	150	183	1.44	

**N/LEST02****STEERING LIGHT IP56**

Body : Cast brass
 Lens : Clear glass, green screen
 LED : 1W LED package
 Cable entry : 1 cable gland

Model no.	Capacity	L(mm)	W(mm)	H(mm)	Weight(kg)	Remarks
N/LEST02	1.8W	11	25	77	1.38	

**N/LEAC03-R****AIRCRAFT WARNING LIGHT IP56**

Body : Brass plate & Cast brass
 Globe : Red glass
 LED : 1W LED package
 Cable entry : 1 cable gland

Model no.	Capacity	L(mm)	W(mm)	H(mm)	Weight(kg)	Remarks
N/LESC03-R	3W	135	135	200	2.13	

LED LIGHTING FIXTURE FOR NAVAL VESSEL

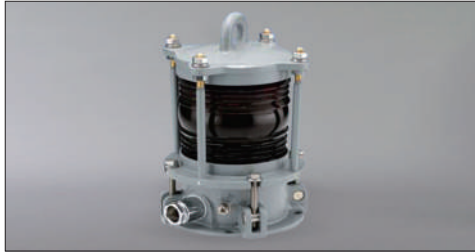

N/LETK03-R(W)

TASK LIGHT IP56
Red / White

Body : Cast brass
Globe : Red glass, clear glass
LED : 1W LED package
Cable entry : 1 cable gland

Model no.	Capacity	L (mm)	W (mm)	H (mm)	Weight (kg)	Remarks
N/LETK03-R	3W	140	140	230	6.6	RED
N/LETK03-W	3W	140	140	230	6.6	CLEAR



N/LEWL06

WAKE LIGHT IP56

Body : Brass plste
Globe : Red glass
LED : 1W LED package
Cable entry : 1 cable gland

Model no.	Capacity	L(mm)	W(mm)	H(mm)	Weight(kg)	Remarks
N/LEWL06	6W	86	86	166	0.47	



N/LEASW06

ASW-REVOLVING LIGHT IP56
Red / Green / Yellow / Blue

Navigation light 360° 3N.miles, 80~100rpm
Body : Aluminium
Globe : Red, Green, Yellow, Blue
LED : 1W LED package
Cable entry : 1 cable gland

Model no.	Capacity	L(mm)	W(mm)	H(mm)	Weight(kg)	Remarks
N/LEASW06R	6W	250	250	240	5.8	Red
N/LEASW06G	6W	250	250	240	5.8	Green
N/LEASW06Y	6W	250	250	240	5.8	Yellow
N/LEASW06B	6W	250	250	240	5.8	Blue



N/LEBL1202

BLINKER LIGHT IP56
White

Body : Cast brass
Globe : Clear glass
LED : 2W Bulb type
Cable entry : 1 cable gland

Model no.	Capacity	L(mm)	W(mm)	H(mm)	Weight(kg)	Remarks
N/LEBL1202	2Wx12	712	712	310	7.3	

LED LIGHTING FIXTURE FOR NAVAL VESSEL

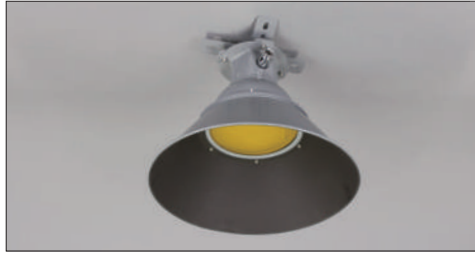
**N/PB200-R****BOAT DECK LIGHT IP56**

Boat deck area
 Body : Brass plate
 Globe : Red globe
 Lamp & Holder : AC120/220V, 200W, E27
 Cable entry : 2 cable glands

Model no.	Capacity	L (mm)	W (mm)	H (mm)	Weight (kg)	Remarks
N/PB200-R	200W	440	440	361	4.2	

**N/PG200-P****GANG WAY LIGHT, PORTABLE IP56**

Gang way area
 Body : Brass plate
 Globe : Clear glass
 Lamp & Holder : AC120/220V, 200W, E27
 Cable entry : 2 cable glands

Model no.	Capacity	L(mm)	W(mm)	H(mm)	Weight(kg)	Remarks
N/PG200-P	200W	250	250	337	3.6	

**N/PWS300****WATERLINE SECURITY LIGHT IP56**

Body : Aluminium plate
 Lamp : Sealed beam lamp AC 120V 300W PAR56
 Cable entry : 1 cable gland

Model no.	Capacity	L(mm)	W(mm)	H(mm)	Weight(kg)	Remarks
N/PWS300	300W	301	255	224	3.4	

**N/PS1K****INCAN. SIGNALLING SEARCH LIGHT IP56**

Body : Aluminium plate
 Cable entry : 1 cable gland
 Lens : Red, Green, Amber
 Lamp & Holder : AC120/220V, 1000W

Model no.	Capacity	L(mm)	W(mm)	H(mm)	Weight(kg)	Remarks
N/PSIK	1000W	510	558	762	40	

LED LIGHTING FIXTURE FOR NAVAL VESSEL



N/SR-DS

ROTARY SWITCH IP56

Engine room, Accomdation area, store
 Body : Brass plate
 Switch unit : AC250V, 10A, DPST
 Cable entry : 2 cable glands

Model no.	Capacity	L (mm)	W (mm)	H (mm)	Weight (kg)	Remarks
N/SR-DS	10A	117	117	90	0.9	



N/SR-RW

SELECTING ROTARY SWITCH
 Red / White **IP56**

Engine room, Accomdation area, store
 Body : Brass plate
 Switch unit : AC250V, 10A
 Cable entry : 2 cable glands

Model no.	Capacity	L(mm)	W(mm)	H(mm)	Weight(kg)	Remarks
N/SR-RW	10A	117	117	90	0.9	Red/White



N/SR-DD

3-WAY ROTARY SWITCH IP56

Engine room, Accomdation area, store
 Body : Brass plate
 Switch unit : AC250V, 10A DPDT
 Cable entry : 2 cable glands

Model no.	Capacity	L(mm)	W(mm)	H(mm)	Weight(kg)	Remarks
N/SR-DD	10A	117	117	90	0.9	



N/RT-W3S

RECEPTACLE WITH SWITCH IP56

Engine room, Accomdation area, store
 Body : Brass plate
 Blind cover
 Switch handle : PC
 Switch & Receptacle unit : AC250V, 15A DPST, 2P+1E
 Cable entry : 1 cable gland

Model no.	Capacity	L(mm)	W(mm)	H(mm)	Weight(kg)	Remarks
N/RT-W3S	10A	110	98	163	1.5	

LED LIGHTING FIXTURE FOR NAVAL VESSEL

**N/SD-1****DOOR OPERATED SWITCH IP56**
1-circuit

Engine room, Accomdation area
 Body & lever : Brass plate & cast brass
 Micro Switch unit : AC250V, 15A, 1 Circuit
 Cable entry : 2 cable glands

Model no.	Capacity	L (mm)	W (mm)	H (mm)	Weight (kg)	Remarks
N/SD-1	15A	118	118	66	1.0	

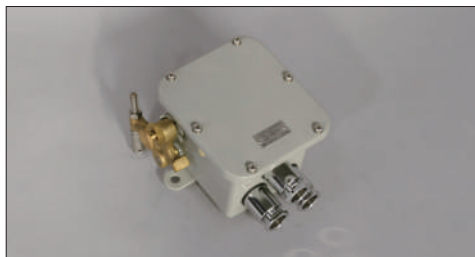
**N/SD-3****DOOR OPERATED SWITCH IP56**
3-circuit

Engine room, Accomdation area
 Body & lever : Brass plate & cast brass
 Micro Switch unit : AC250V, 15A, 3 Circuit
 Cable entry : 2 cable glands

Model no.	Capacity	L(mm)	W(mm)	H(mm)	Weight(kg)	Remarks
N/SD-3	1.8W					

**N/RT-W3****WATERTIGHT RECEPRACLE IP56**

Engine room, Accomdation area, store
 Body : Brass plate
 Receptacle unit : AC250V, 15A, 2P+1E
 Cable entry : 2 cable glands

Model no.	Capacity	L(mm)	W(mm)	H(mm)	Weight(kg)	Remarks
N/RT-W3	15A	118	118	66	1.0	

**N/PG-W3PU****WATERTIGHT PLUG IP56**

Engine room, Accomdation area, store
 Body : Nylon
 Plug unit : AC250V, 15A, 2P+1E

Model no.	Capacity	L(mm)	W(mm)	H(mm)	Weight(kg)	Remarks
N/PG-W3PU	15A	53	53	100	0.1	

**LED
LIGHTING FIXTURE
FOR ON-SHORE**



**KD-T8DO****TUBE TYPE LED LAMP**

Office & Working Room
 Body : aluminium bar/pc
 Diffuser : Milky polycarbonate
 LED : 0.2W module type
 Lamp base : G13

Model no.	Capacity	L (mm)	W (mm)	LM	Weight (kg)	Remarks
KD-T8DO-9W	9W	585	26	900	0.20	T8,G13
KD-T8DO-11W	11W	585	26	1100	0.20	T8,G13
KD-T8DO-18W	18W	1198	26	1800	0.38	T8,G13
KD-T8DO-22W	22W	1198	26	2200	0.38	T8,G13

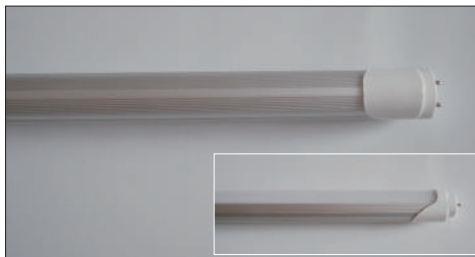
**KD-T8DI30****TUBE TYPE LED LAMP**

Office & Working Room
 Body : aluminium bar/pc
 Diffuser : Milky polycarbonate
 LED : 0.2W module type

Model no.	Capacity	L (mm)	W (mm)	LM	Weight (kg)	Remarks
KD-T8DI30-18W	18W	1200	26	1720	0.30	T8,G13
KD-T8DI30B-18W	18W	1200	26	1720	0.30	BASE TYPE

**KD-BR****LED PAR LAMP**

Office & Working Room
 Body : aluminium bar
 Diffuser : Polycarbonate
 LED : 3W Bulb type
 Lamp holder : E26/27

Model no.	Capacity	L(mm)	W(mm)	H(mm)	Weight(kg)	Remarks
KD-BR03	3W	76	50	122	0.2	

**KD-BE****LED BULB LAMP**

Office & Working Room
 Body : aluminium
 Diffuser : Polycarbonate
 LED : 6, 7.2W Bulb type
 Lamp holder : E26/27

Model no.	Capacity	L(mm)	W(mm)	H(mm)	Weight(kg)	Remarks
KD-BE06	6W	60	60	160	0.3	
KD-BE08	7.2W	60	60	160	0.3	

**KD-TFD*****LED DOWN LIGHT IP22**

Body : Aluminium sheet deep drawn
 Diffuser : Milky polycarbonate
 LED : 1W chip package

Model no.	Capacity	L (mm)	W (mm)	H (mm)	Weight (kg)	Remarks
KD-TFD7W	7W	75	144	220	0.39	
KD-TFD9W	9W	75	198	290	0.36	

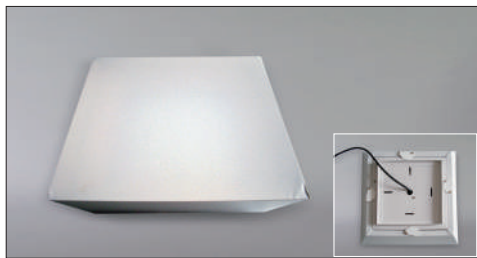
**KD-PL3535-20W****LED PANEL LIGHT IP22**

Hotel & guesthouse & synagogue & club house
 Body : Electro zinc galvanized steel sheet
 Diffuser : Milky polycarbonate
 LED : 0.2W module type

Model no.	Capacity	L(mm)	W(mm)	H(mm)	Weight(kg)	Remarks
KD-PL3535-20W	20W	350	350	100	2.64	1200 lm

**KD-PL3570-40W****LED PANEL LIGHT IP22**

Hotel & guesthouse & synagogue & club house
 Body : Electro zinc galvanized steel sheet
 Diffuser : Milky polycarbonate
 LED : 0.2W module type

Model no.	Capacity	L(mm)	W(mm)	H(mm)	Weight(kg)	Remarks
KD-PL3570-40W	40W	350	700	100	4.54	2400 lm

**KD-PL7070-60W****LED PANEL LIGHT IP22**

Hotel & guesthouse & synagogue & club house
 Body : Electro zinc galvanized steel sheet
 Diffuser : Milky polycarbonate
 LED : 0.2W module type

Model no.	Capacity	L(mm)	W(mm)	H(mm)	Weight(kg)	Remarks
KD-PL7070-60W	60W	700	700	100	7.48	3600 lm

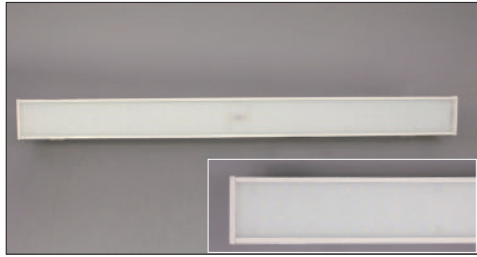
**KD-LPFP-1008D****LED CEILING LIGHT IP20**

Display stand, underground, parking
 Body : aluminium
 LED : 0.2W module type
 Voltage & frequency : AC100~240V, 50/60HZ

Model no.	Capacity	L (mm)	W (mm)	H (mm)	Weight (kg)	Remarks
KD-LPFP-1008D	25W	800	102	54	2.00	2300lm

**KD-LPFP-1012D****LED CEILING LIGHT IP20**

Display stand, underground, parking
 Body : aluminium
 LED : 0.2W module type
 Voltage & frequency : AC100~240V

Model no.	Capacity	L(mm)	W(mm)	H(mm)	Weight(kg)	Remarks
KD-LPFP-1012D	40W	1200	102	54	3.00	3400lm

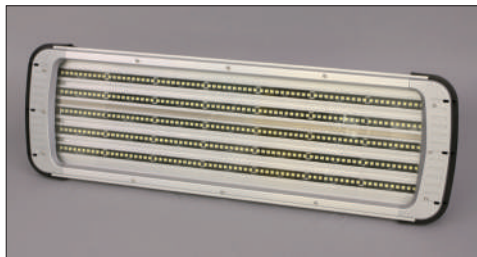
**KD-LPFP-120W****LED CEILING LIGHT IP56**

Crosswalk, workshop
 Body : aluminium
 LED : 0.2W module type
 Voltage & frequency : AC100~240V

Model no.	Capacity	L(mm)	W(mm)	H(mm)	Weight(kg)	Remarks
KD-LPFP-120W	120W	500	170	65	10	

**KD-LPFP-100W****LED CEILING LIGHT IP56**

Crosswalk, workshop
 Body : aluminium
 LED : 0.2W module type
 Voltage & frequency : AC100~240V

Model no.	Capacity	L(mm)	W(mm)	H(mm)	Weight(kg)	Remarks
KD-LPFP-100W	100W	650	175	70	8	

LED LIGHTING FIXTURE FOR ON-SHORE



KD-PL50W

LED PLANT LIGHT IP56

Workshop, warehouse, highway tool station, supermarket, exhibition hall
 Body : Aluminium sheet deep drawn
 Shade : Aluminium sheet deep drawn
 LED : 1W chip package
 Voltage & frequency : AC100~240V, 50/60hz

Model no.	Capacity	L (mm)	W (mm)	H (mm)	Weight (kg)	Remarks
KD-PL50W	50W	320	400	3400	4.70	



KD-PL80W

LED PLANT LIGHT IP56

Workshop, warehouse, highway tool station, supermarket, exhibition hall
 Body : Aluminium sheet deep drawn
 Shade : Aluminium sheet deep drawn
 LED : 1W chip package
 Voltage & frequency : AC100~240V, 50/60hz

Model no.	Capacity	L(mm)	W(mm)	H(mm)	Weight(kg)	Remarks
KD-PL80W	80W	390	400	6300	5.00	



KD-PLQI150W

LED PANEL LIGHT IP56

Workshop, warehouse, highway tool station, supermarket, exhibition hall
 Body : Aluminium sheet deep drawn
 Shade : Aluminium sheet deep drawn
 LED : 1W chip package
 Voltage & frequency : AC100~240V, 50/60hz

Model no.	Capacity	L(mm)	W(mm)	H(mm)	Weight(kg)	Remarks
KD-PLQI150W	150W	436	500	15.600	4.75	



KD-PLQI200W

LED PANEL LIGHT IP56

Workshop, warehouse, highway tool station, supermarket, exhibition hall
 Body : Aluminium sheet deep drawn
 Shade : Aluminium sheet deep drawn
 LED : 1W chip package
 Voltage & frequency : AC100~240V, 50/60hz

Model no.	Capacity	L(mm)	W(mm)	H(mm)	Weight(kg)	Remarks
KD-PLQI200W	200W	501	500	19,000	5.60	

**KD-FL50W****LED FLOOD LIGHT IP67**

Hotel & questhouse & synagogue & club house
 Body : aluminium daicasting
 Front glass : Heat and impact resistant glass
 LED : 1W chip package
 Voltage & frequency : AC85~245V, 50/60Hz

Model no.	Capacity	L (mm)	W (mm)	H (mm)	Weight (kg)	Remarks
KD-FL50W	50W	287	237	170	5.20	3400lm

**KD-FL80W****LED FLOOD LIGHT IP67**

Hotel & questhouse & synagogue & club house
 Body : aluminium daicasting
 Front glass : Heat and impact resistant glass
 LED : 1W chip package
 Voltage & frequency : AC85~245V, 50/60Hz

Model no.	Capacity	L(mm)	W(mm)	H(mm)	Weight(kg)	Remarks
KD-FL80W	80W	287	237	170	5.20	6100lm

**KD-TGD80W****LED FLOOD LIGHT IP67**

Hotel & Factory, tunnel
 Body : aluminium daicasting
 Front glass : Heat and impact resistant glass
 LED : 1W chip package
 Voltage & frequency : AC85~245V, 50/60Hz

Model no.	Capacity	L(mm)	W(mm)	H(mm)	Weight(kg)	Remarks
KD-TGD80W	80W	438	234	270	6.80	40° 400lx

**KD-TGD120W****LED FLOOD LIGHT IP67**

Hotel & Factory, tunnel
 Body : aluminium daicasting
 Front glass : Heat and impact resistant glass
 LED : 1W chip package
 Voltage & frequency : AC85~245V, 50/60Hz

Model no.	Capacity	L(mm)	W(mm)	H(mm)	Weight(kg)	Remarks
KD-TGD120W	120W	438	234	160	6.80	40° 450lx

**KD-SLP120****LED STREET LIGHT IP65**

Yard & road
 Body : Aluminium diecasting
 Front glass : Heat and impact resistant glass
 LED : 1W chip package
 Voltage & frequency : AC85~240V, 50/60Hz

Model no.	Capacity	L (mm)	W (mm)	H (mm)	Weight (kg)	Remarks
KD-SLP120	120W	720	400	168	14.0	

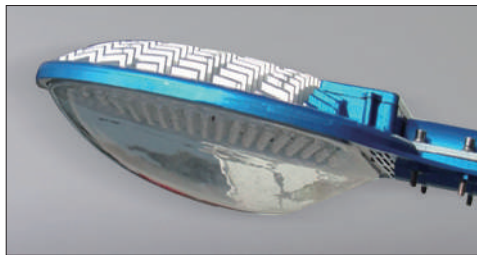
**KD-SLP200****LED STREET LIGHT IP65**

Yard & road
 Body : Aluminium diecasting
 Front glass : Heat and impact resistant glass
 LED : 1W chip package
 Voltage & frequency : AC85~240V, 50/60Hz

Model no.	Capacity	L(mm)	W(mm)	H(mm)	Weight(kg)	Remarks
KD-SLP200	200W	702	400	168	14.0	

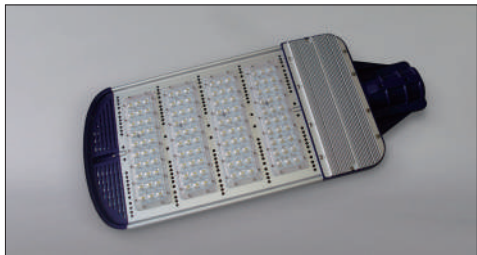
**KD-SL120W****LED STREET LIGHT IP65**

Yard & road
 Body : Aluminium diecasting
 Front glass : Heat and impact resistant glass
 LED : 1W chip package
 Voltage & frequency : AC85~240V, 50/60Hz

Model no.	Capacity	L(mm)	W(mm)	H(mm)	Weight(kg)	Remarks
KD-SL120W	120W	742	316	85	9.40	

**KD-SL150W****LED STREET LIGHT IP65**

Yard & road
 Body : Aluminium diecasting
 Front glass : Heat and impact resistant glass
 LED : 1W chip package
 Voltage & frequency : AC85~240V, 50/60Hz

Model no.	Capacity	L(mm)	W(mm)	H(mm)	Weight(kg)	Remarks
KD-SL150W	150W	835	310	85	10.5	

LED LIGHTING FIXTURE FOR ON-SHORE



ELX-F32

EX-P. WORKING LIGHT IP66

Hazardous areas, Zone 2, Ex "nA" Non sparking
 Body : Polycarbonate
 Globe : Clear Polycarbonate
 Reflector : Highly polished aluminium, anodized
 Cable entry : 1 cable glands (PG13.5)
 Voltage & frequency : AC220V, 60Hz Finished : Maker standard

Model no.	Capacity	L (mm)	W (mm)	H (mm)	Weight (kg)	Remarks
ELX-F32H	32W	170	170	384	1.0	Hanging type
ELX-F32P	32W	170	199	288	1.05	Portable type



EL-F32

WORKING LIGHT IP66

In new shipbuilding at shipyards asportable working light
 Body : Polycarbonate
 Globe : Clear Polycarbonate
 Reflector : Highly polished aluminium, anodized
 Cable entry : 1 cable glands (PG13.5)
 Voltage & frequency : AC220V, 60Hz Finished : Maker standard

Model no.	Capacity	L(mm)	W(mm)	H(mm)	Weight(kg)	Remarks
EL-F32F	32W	170	170	384	0.95	
EL-F32B	32W	170	179	288	0.95	

• Optional : with 3m, 7m, 10m cable, & plug



1 : HANGER TYPE EL-F32H
 FPL 32W x 1 (CEILING M/T)



2 : HANGER TYPE EL-F32H
 FPL 32W x 1 (EALL M/T)



3 : BRACKET TYPE
 EL-F32B FPL 32W x 1



4 : PORTABLE TYPE
 EL-F32P FPL 32W x 1



5 : STAND TYPE
 EL-F36S4 FPL 36W x 4



6 : STAND TYPE
 EL-F36S3 FPL 36W x 3



7 : STAND TYPE
 EL-F32S4 FPL 32W x 4



8 : STAND TYPE
 EL-F32S5 FPL 32W x 5

Application

- 1 : For ceiling (Steel) on Shipboard and Yards
- 2 : For Wall (Steel) on Shipboard and Yards
- 3 : For Stair Way, Passage Way and Outdoors
- 4,5 : For Portable use on Working Areas
- 6-8 : For Brightness of Working Areas for Ceiling and Well

Illuminance[lx]

- Distance 1M from Lighting Sources
- 1~4 : 170 [lx]
- 5 : 732 [lx]
- 6 : 457 [lx]
- 7 : 588 [lx]
- 8 : 697 [lx]

REEFER CONTAINER SOCKETS & MONITORING SYSTEM

RECEPTACLE 1

RECEPTACLE 2

REEFER CONTAINER SOCKET



RCS2-*PP SOCKET OUTLET PUSH- PULL TYPE IP56/67 ONE(1) COVER TYPE

Container vessel
 Body & cover : Welding Stainless steel construction. One(1) cover type
 Sealing : Highly flexible allow seal for the cover
 Socket : Integrated with resin socket flange. 32A, 3P+1E
 Cable entry : 1-Cable gland
 Voltage & frequency : AC440V, 60Hz

Model no.	Capacity	L (mm)	W (mm)	H (mm)	Weight (kg)	Remarks
RCS2-321F-PP	32A 1GANG	300	290	155	11.7	
RCS2-322F-PP	32A 2GANG	440	290	155	15.5	
RCS2-323F-PP	32A 3GANG	560	290	155	18.4	
RCS2-324F-PP	32A 4GANG	680	290	155	22.1	
RCS2-325F-PP	32A 5GANG	800	290	155	26.4	
RCS2-326F-PP	32A 6GANG	920	290	155	30.8	
RCS2-327F-PP	32A 7GANG	1076	290	155	35.2	
RCS2-328F-PP	32A 8GANG	1196	290	155	40.7	



RCS2-*PP3 SOCKET OUTLET PUSH- PULL TYPE IP56/67 ONE(3) COVER TYPE

Container vessel
 Body & cover : Welding Stainless steel construction. Three(3) cover type
 Sealing : Highly flexible allow seal for the cover
 Socket : Integrated with resin socket flange. 32A, 3P+1E
 Cable entry : 1-Cable gland
 Voltage & frequency : AC440V, 60Hz

Model no.	Capacity	L(mm)	W(mm)	H(mm)	Weight(kg)	Remarks
RCS2-329F-PP3	32A 9GANG	1430	290	155	46.20	
RCS2-3210F-PP3	32A 10GANG	1550	290	155	52.00	



RCS2-*PT SOCKET OUTLETS TURN TYPE IP56/67

Container vessel
 Body & cover : Welding Stainless steel construction. ONE(1) cover type
 Sealing : Highly flexible allow seal for the cover
 Socket : Integrated with resin socket flange. 32A 3P+1E
 Cable entry : 1-Cable gland
 Voltage & frequency : AC440V, 60Hz

Model no.	Capacity	L (mm)	W (mm)	H (mm)	Weight (kg)	Remarks
RCS2-321F-PT	32A 1GANG	310	270	145	5.5	
RCS2-322F-PT	32A 2GANG	430	270	145	8.5	
RCS2-323F-PT	32A 3GANG	550	270	145	11.5	
RCS2-324F-PT	32A 4GANG	670	270	145	14.5	
RCS2-325F-PT	32A 5GANG	790	270	145	17.5	
RCS2-326F-PT	32A 6GANG	910	270	145	20.5	
RCS2-327F-PT	32A 7GANG	1070	270	145	23.5	
RCS2-328F-PT	32A 8GANG	1190	270	145	26.5	
RCS2-329F-PT	32A 9GANG	1310	270	145	29.5	
RCS2-3210F-PT	32A 10GANG	1430	270	145	32.5	

- 380VAC to 440VAC, 32A (C.E.E / I.E / I.S.O)

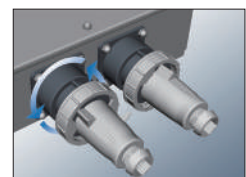
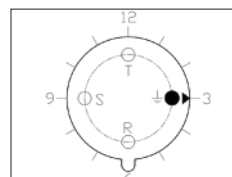

EM-RCS (Energy Monitoring - Reefer Container Socket)

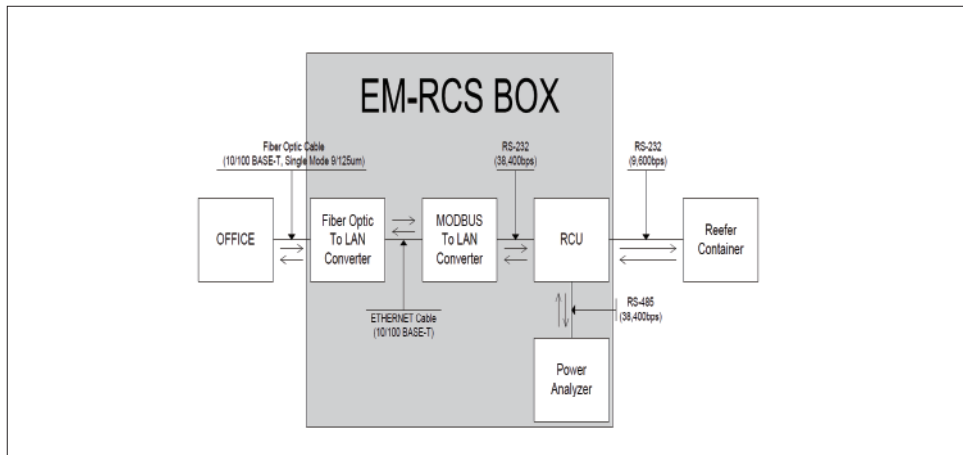

Main Function

- Monitors alarm and temperature conditions
- Sends commands such as change of set-point temperature
- Generates user friendly reports
- Registers the history of each container
- Measures power consumption

Communications : Fiber Optic / LAN / Wi-Fi
Applications : Container Ship, Port

Advantage

EM-RCS enables just one operator to monitor entire container terminal. This system allows two way communication between the TOS and each reeper container. This system records all required data in detail and generates alarm when there's any problems in the reeper container.

- Simple Operation
- Simultaneous Communication.
- Convenient System Expansion
- Reduction in Labor and Expense
- Cargo Claims Can Be Effectively Defended
- Increase in Safety for Users.
- Quick & Stable Communication



EM-RCC (Energy Monitoring - Reefer Container Communicator)

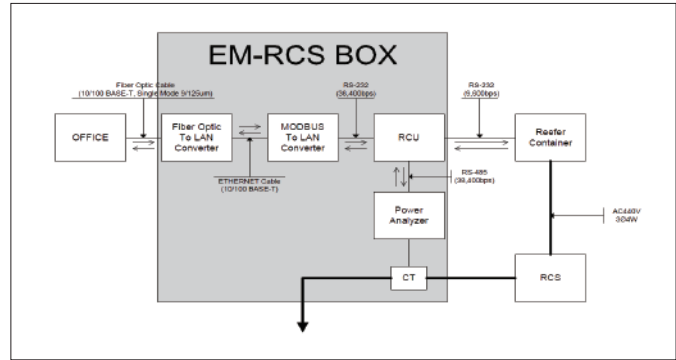
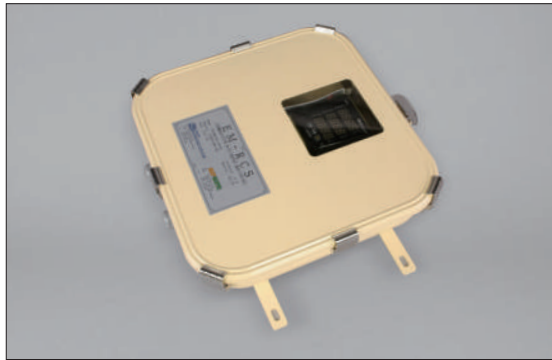

Main Function

- Monitors alarm and temperature conditions
- Sends commands such as change of set-point temperature
- Generates user friendly reports
- Registers the history of each container
- Measures power consumption

Communications : Fiber Optic / LAN / Wi-Fi

Applications : Container Ship, Port where RCS has been already installed

RCC (Reefer Container Communicator)

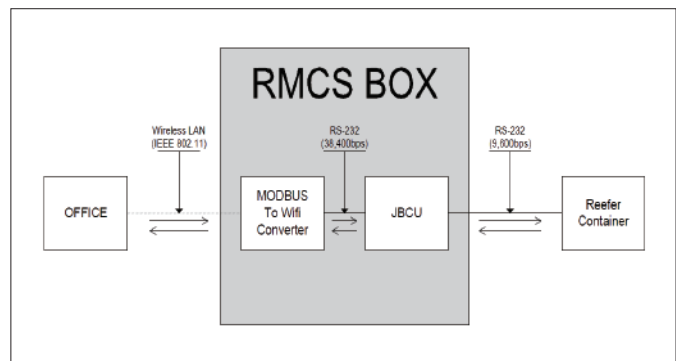

Main Function

- Monitors alarm and temperature conditions
- Sends commands such as change of set-point temperature
- Generates user friendly reports
- Registers the history of each container

Communications : Fiber Optic / LAN / Wi-Fi

Applications : Container Ship, Port

Applications : Container Ship, Port where RCS has been already installed

"GLOBAL KOREA, GLOBAL KUKDONG"

KUKDONG ELECOM's LED technology that has progressed toward the world.
KUKDONG ELECOM'S LED opens a beautiful and bright world.



LED DNV



IECEX Certificate of Conformity



LED working light patent



LED fluorescent light patent



LED patent





Leading Enterprise for Energy Saving Innovation

극동일렉콤주식회사
KUKDONG ELECOM

- **KUKDONGELECOM**
128, DASAN-RO, SAHA-GU, BUSAN, KOREA
TEL: +82-51-266-0050 FAX: +82-51-265-0985
- **KESKOM**
ROOM 15/16, NO 110, SEOBUSAN T-PLEX,
3153-1, DAEJEO2-DONG, GANGSEO-GU,
BUSAN, KOREA
TEL: +82-51-245-5111 FAX: +82-51-261-0030
- **KUKDONGELECOM - DALIAN**
#49, GUSHAN STREET,
DAGUSHAN DEVELOPMENT ZONE, DALIAN, CHINA
TEL: +86-411-3921-8000 FAX: +86-411-3921-8008
- **Mail : kdecom@kdkorea.net**