

# MODEL: SP2nd

(Portable Single Gas Detector)

# Operating Manual



Version 2.2

**SENKO**  
SenKo Co., Ltd

---

## Guarantee and Repair

Senko Co., Ltd. guarantees the products of SP series for 24 months from the shipping date and repairs or replaces the defected product during warranty period. Nevertheless, Senko is not responsible for the following cases and would not repair or replace the product at no cost, such cases as the product has been purchased through the route that Senko does not approve, or as the product has been damaged or deformed mechanically by misuse of the user, or as the product has not been calibrated or replaced the parts according to processes in the operating manual.

In the event that any defect or issue of the product occurred during warranty period, Senko will cover all the expenses except transportation fee. After the period of warranty, the expenses of repair or replacement of the product and transportation will be in principle borne by the user. Senko will not be responsible for any indirect occurrence or accident and/or damage during the use of the product, and the guarantee shall be limited to the replacement of parts and product. The guarantee is applied only to the users who purchased the product at Senko's authorized dealers or agents, and the guaranteed repair is to be performed by the expert engineers of Senko's authorized aftercare center.

## Product Introduction

SP2nd is Simple Gas Alarm Detector that is required to protect users' safety at dangerous work environments. The apparatus can indicate simultaneously the concentration of gases (Oxygen, Carbon Monoxide, Hydrogen Sulfide, Hydrogen, Sulfur Dioxide, Hydrogen Chloride, Ammonia and etc.) on a digital LCD monitor, and the methods of operation and calibration are easy and convenient.

This instrument alerts accurately the alarm circumstances to operators and workers for their safety with its functions of loud alarm sound and vibration, when higher gas concentration than normality is detected. Besides, it is available for users to check upon occasion and adjust the value of alarm to the work environment on demand, since it has the function of indicating minimal and maximal concentration of the gases. It is also possible to prevent in advance workers from the danger of exposing for a definite period of time to such toxic gases as Hydrogen Sulfide( $H_2S$ ), Carbon Monoxide( $CO$ ) and Sulfur Dioxide( $SO_2$ ) by its function of STEL(Short Term Exposure Limit) and TWA(Time Weighted Average).

---

# Contents of Operating Manual

<b>Product Specification</b>	<b>03</b>
<b>Names of Exterior and Display</b>	<b>04</b>
<b>Start and End of Operation</b>	<b>05</b>
<b>Operation Method</b>	<b>06</b>
<b>Backlight</b>	<b>06</b>
<b>Data Log</b>	<b>07</b>
<b>Calibration</b>	<b>08</b>
<b>Day and Time</b>	<b>10</b>
<b>Method of Alarm Set and Display</b>	<b>11</b>
<b>Battery &amp; Sensor replacement</b>	<b>13</b>
<b>Applicable Battery and External Pump</b>	<b>14</b>
<b>Notice for User</b>	<b>15</b>

# 1. Product Specification(SP2nd)

Model	SP2217	SP2227	SP2257	SP2277	SP2297	SP22L7	SP22N7	SP22C7
Measured Gas	O <sub>2</sub>	CO	SO <sub>2</sub>	H <sub>2</sub>	H <sub>2</sub> S	Cl <sub>2</sub>	NH <sub>3</sub>	NO <sub>2</sub>
Measured Range	0~30 %Vol	0~500 ppm	0~20 ppm	0~1000 ppm	0~100 ppm	0~20 ppm	0~100 ppm	0~20 ppm
Measurement Method	Electrochemical Type							
Principle of Measurement	Diffusion Type							
Monitor	LCD display (Built in back light)							
Alarm	90dB							
Alert Lamp	Red LED (Light-Emitting Diode)							
Vibration Alert	Vibration Alarm(Rated Speed : 6,000 ± 1,000RPM)							
Power source	SB-AA02 (Lithium $\frac{1}{2}$ AA Battery, 3.6V/1.2Ah)							
Applicable Temperature & Humidity	-20℃ ~ +50℃ , : 5% ~ 95% RH (non-condensing)							
Explosion-Proof	Ex ia IIC T4 / IP67 (KGS, ATEX)							
Case	Rubber PC Case							
Standard Accessories	Belt Clip, Calibration Cap							
Optional Accessories	Small-Sized Pump for Sampling(SP-Pump101)							
Exterior	Dimension : 54mm(W) x 91mm(H) x 32 mm(D) Weight :120g (Including Battery)							
Event Log	Save the latest 20 data							

## 2. Names and Functions of Exterior

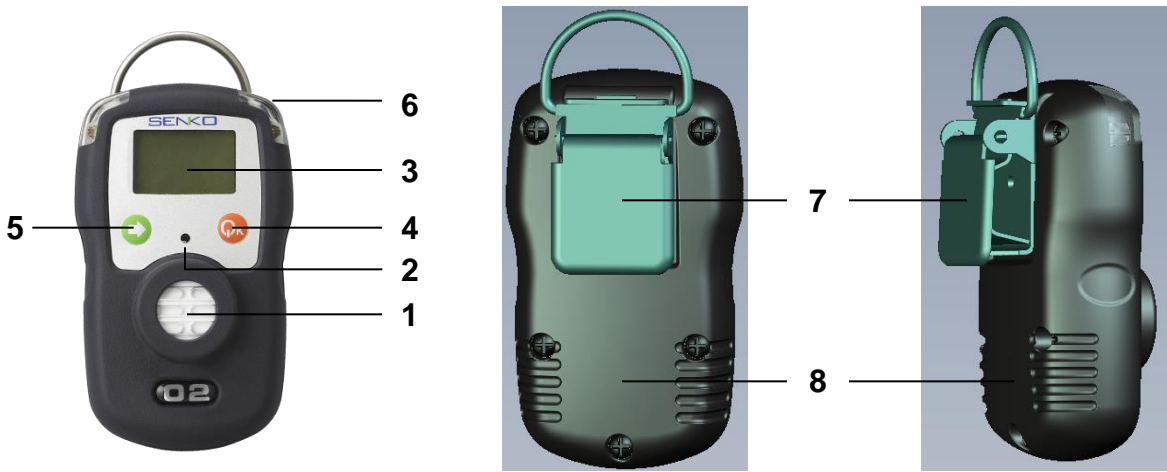

- |                |                   |
|----------------|-------------------|
| 1. Gas sensor  | 5. Arrow Key      |
| 2. Buzzer      | 6. Alarm LED      |
| 3. LCD display | 7. Fastening clip |
| 4. Power Key   | 8. Type label     |



### LCD display symbols





- |              |                        |  |                          |
|--------------|------------------------|--|--------------------------|
| <b>ALARM</b> | Alarm                  |  | Date                     |
|              | First Alarm            |  | Month                    |
|              | Second Alarm           |  | Time                     |
|              | Safety Success         |  | Log Value                |
|              | Safety Failure         | <b>TWA</b>                               | Time Average Level Alarm |
|              | Fresh Air Calibration  | <b>STEL</b>                              | Time Average Level Alarm |
|              | Single Gas Calibration | <b>MAX</b>                               | Max Peak Value           |
|              | Battery                | <b>MIN</b>                               | Min Peak Value           |
|              |                        | <b>%LEL</b><br><b>PPM</b><br><b>%VOL</b> | Unit                     |

### 3. Start and End of Operation

#### Instrument Power-On

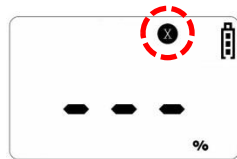
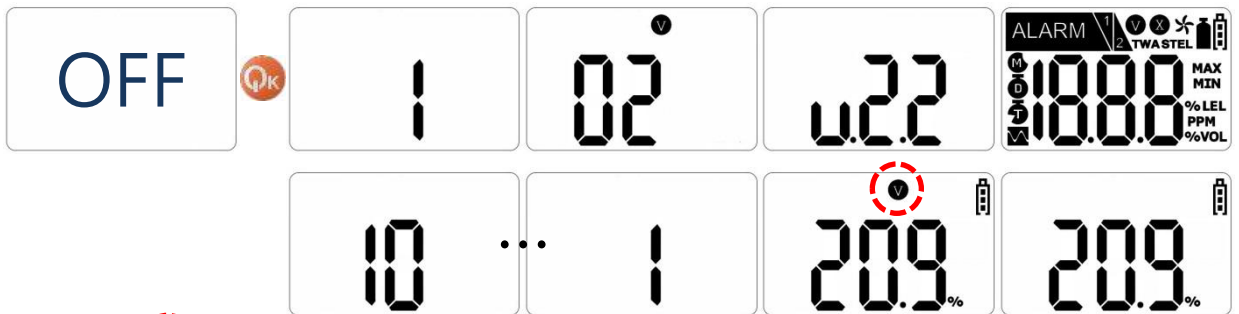
Press Power key for a few seconds, and power is turned on. Measured gas and version appear on the screen. Afterwards during the instrument is being stabilized, the countdown appears on the screen. When the instrument is stabilized after the display of the above set values, it converts to Gas Detection Mode displaying  icon. At normal status,  icon disappears after blinking several times, and the concentration of the gas detected of the moment is indicated.



In the event that stabilization of the instrument fails, it would not convert to Gas Detection Mode, blinking the mark . In this case, calibration of the sensor or aftercare of the instrument is required.

#### Instrument Power-Off

Press Power key for a few seconds then power is turned off displaying countdown in order on the monitor.

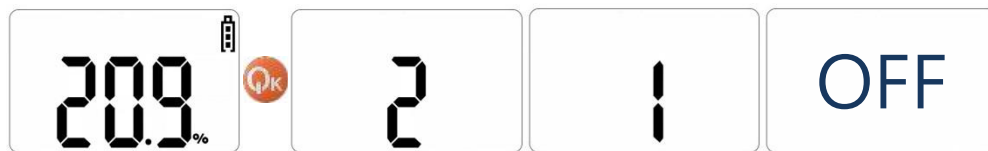

If power key is pressed at any mode except the Gas Detection Mode or power key isn't pressed for a few seconds, power isn't turned on.

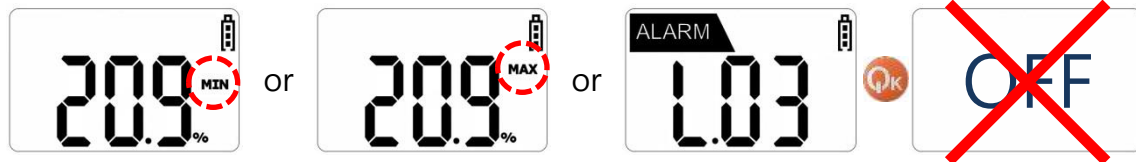



**<Caution>** Appropriate calibration of the instrument is always required prior to the operation at work sites. Make sure if the instrument makes the proper detection response to the pertinent gas and if the region of the gas detection is not blocked with foreign materials that interfere with the gas detection.

## 4. Operation Method

### Detection Mode



The instrument is converted to Gas Measure Mode as below, when power is turned on. Gas Measure Mode indicates the concentration of gas and the remained capacity of battery on LCD, and it displays the gas concentration of Oxygen by %, and such toxic gases as H<sub>2</sub>S, CO and SO<sub>2</sub> by ppm units.

In the event that the concentration of gas changes, it indicates the value of concentration in real-time. If it exceeds the 1st Alarm(**LO**) or 2nd Alarm(**HI**) standard (or STEL / TWA), the measured value and  icon or  icon (**STEL**, **TWA** icon in case of STEL / TWA) blinks periodically with the alerts by alarm sound and vibration. When the operator moves to the safe place where the concentration value of the measured gas is the normal state, the concentration value reduces and the alarm stops. (Even if the operator escapes to a safe area after the alarm alerts, the icon of alarm remains on the screen, and it will disappear only after confirming the value by pressing Power key. When the concentration value of the measured gas exceeds the maximum measuring range, it is indicated as the maximum value. And LED, alarm sound and vibration applicable to 2nd Alarm Standard operate together.

### Indication of Peak Value and TWA & STEL Value



At Gas Measure Mode, in case of Oxygen, the measured minimum and maximum values are displayed in order. And in case of Toxic Gases, maximum value, STEL value and TWA value are displayed consecutively. Program returns to Measure Mode, when Power key is pressed at state displaying Peak, STEL and TWA. If the button is not touched for several seconds, the program will return to Gas Measure Mode.

## 5. LCD Backlight



At the state of Gas Detection Mode indicating the concentration of gases simultaneously, LED Backlight is turned on by the short press on Arrow key, that enables the operator to view the measured value even at dark atmosphere. It is turned off by pressing again once more. Backlight will be automatically turned off after several seconds unless the button works.

# 6. Data Log

## Alarm Data

At Gas Detection Mode, whenever short press Power key once, Data Log Mode is displayed after the measured minimum, maximum, STEL, TWA values are displayed in order. In order word, press four time(In case of Oxygen, three time), Data Log Mode is displayed.



Data Select Mode is displayed by pressing Arrow key. At this mode, data is selected and a record is confirmed. Again press Power key once, year, month, day, time and alarm recorded are confirmed. If Arrow key is pressed at year, month, day, time display, the program returns to Data Select Mode.

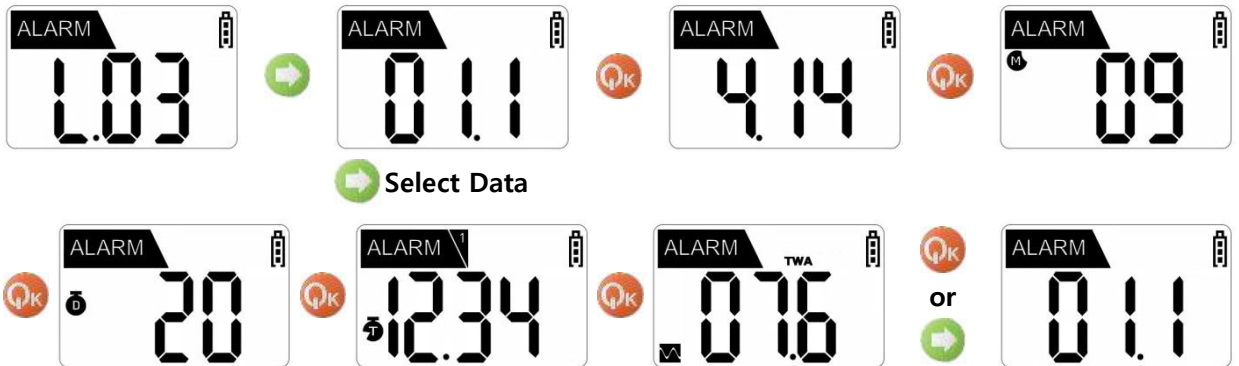

'L' of 'L.03' means Log and '03' means the number of date. Consequently, the program is saved three data.

At Data Select Mode '01.1', left number '01' means data and right number '1' means occurred alarm('1' is 1st alarm or '2' is 2st alarm). In order word, first data of saved three data means occurred 1st alarm value. If another data is confirmed, data is selected by pressing Arrow key. Also if Arrow key is pressed at final data, program returns to Gas Measure Mode.

Data is saved to twenty number and if the number of data is over twenty, data is removed automatically in order of data that is stored the in the beginning



# 7. Calibration

**<Caution>** Senko Co., Ltd. performs the initial calibration before the shipment. Incorrectly calibrated value can reduce the accuracy of the product, as the calibrated value is stored in the instrument. Calibration is in general to be performed monthly or quarterly, and can be adjusted according to frequency of the use.

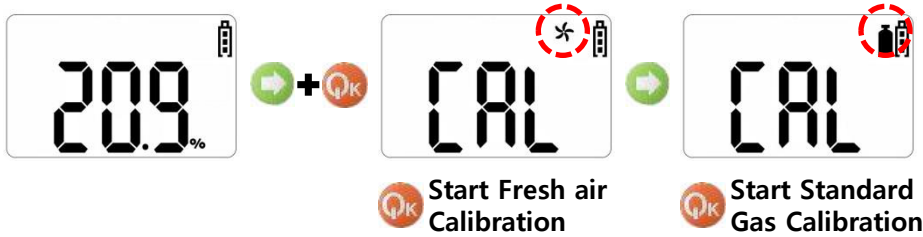

## Fresh air Calibration

✱ icon appears when Power key is pressed a few seconds at the state of pressing Arrow key simultaneously. Program will enter to Calibration Mode of Standby State. When Calibration starts, countdown 10, 9, 8.....3, 2, 1 continues for 10 seconds and Calibration will be completed. If Calibration is completed normally, it returns to Gas Measure Mode after several times blinking of V icon

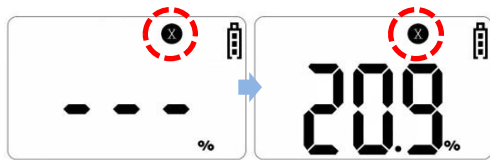
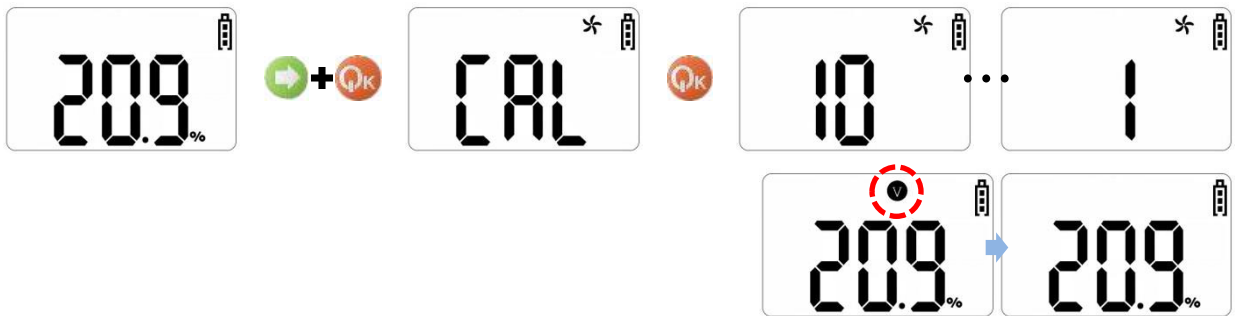

If Standby State Calibration failed, X icon appears continuously. If this occurrence repeats, please consult a dealer or aftercare center to replace the sensor.

**<Caution>** Fresh Gas Calibration should be performed at the environment of fresh air without any influence of other gases, since the calibration is performed on the assumption that the concentration of Oxygen is 20.9%, that of Inflammable Gas is 0%LEL, and the concentration of Toxic Gas is 0ppm in the fresh air. Accordingly it is not recommended to perform Fresh Air Calibration at the closed space, and it should be avoided to perform the calibration where gases can be inhaled by operators.

## Standard Gas Calibration

\* icon appears when Power key is pressed a few seconds at the state of pushing Arrow key simultaneously. And  icon appears by input of Arrow key at the state. Standard Gas Calibration starts by pressing Power key for a few seconds displaying countdown. Be careful not to proceed with Calibration at the state without connecting with Standard Gas.

When Standard Gas Calibration starts, in case of Oxygen, Calibration proceeds by the countdown for 90 seconds. If the Calibration is normally executed, the concentration value of the gas connected at the moment is indicated with displaying  icon. Afterwards, it indicates the concentration value measured at the moment, when Standard Gas is disconnected.

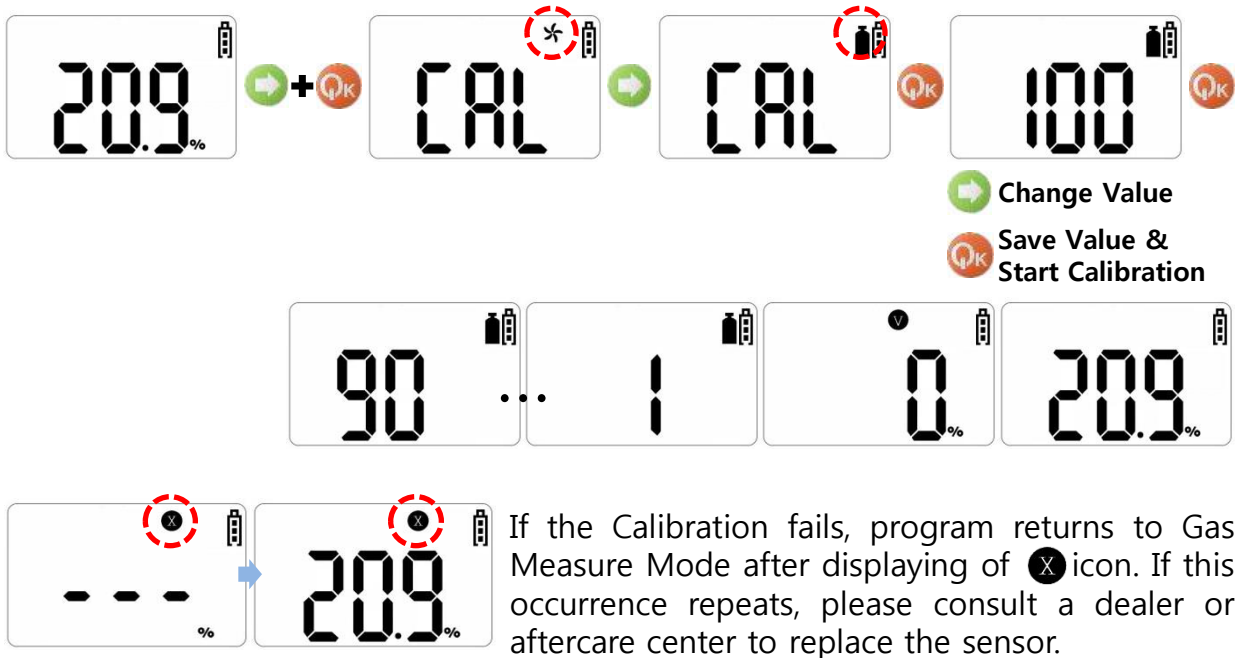

## Concentration of Calibration Gas Set to Instrument

Gas	O <sub>2</sub>	CO	SO <sub>2</sub>	H <sub>2</sub>	H <sub>2</sub> S	Cl <sub>2</sub>	NH <sub>3</sub>	NO <sub>2</sub>
농도	0%	100 ppm	10 ppm	500 ppm	50 ppm	10 ppm	50 ppm	10 ppm

# 8. Date and Time

## Date and Time View

At Gas Detection Mode, press Arrow key for three seconds, Date and Time View Mode is displayed. At this moment, short press Arrow key. Then the present time, year, month, day are confirmed with icon or character equivalent to it. If Power key is at the Present Mode or key is not pressed for several seconds, the program will return to Gas Measure Mode.

▼ icon means AM, and ▲ icon means FM at the Present Time.



## Date and Time Set



At Gas Detection Mode, press Arrow key for three seconds, Date and Time View Mode is displayed. At this moment, press Power key for five seconds. Then the Date and Time Set Mode is displayed and number flickers. Press Arrow key, change value(Press long Arrow key, increase value quickly) and press Power key, save value.

Year set up to 2030 maximum. When using product early, user must set exact date and time because of not doing ship setting exact date and time



## 9. Method of Alarm Set and Display

### Alarm Set

When Arrow key is pressed for a few seconds at the state of power off, program enters to 1st Alarm Set Mode with displaying of  icon. In this moment, 2nd Alarm(HI) Set Mode with displaying  icon by pressing Arrow key. Press Arrow key one more, display returns to Gas Measure Mode without changing Alarm Set value.

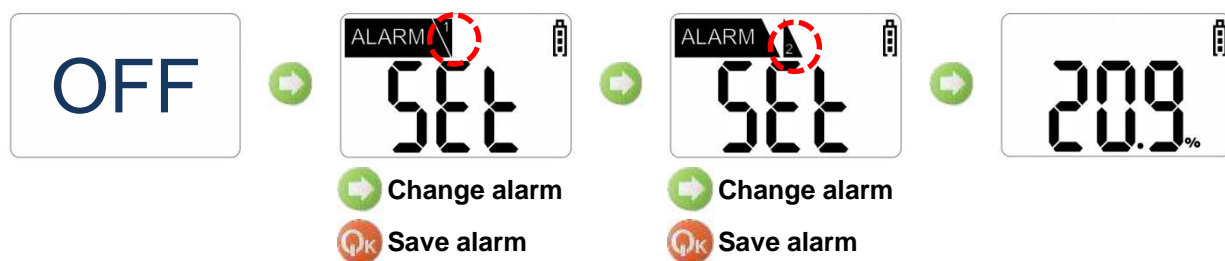

Press Power key at Alarm Set Mode, alarm value is checked. Using Arrow key, change alarm value and using Power key, save alarm value or move number. After final digit changes, press Power key once, program returns to Alarm Set Mode

Press Arrow key at 1st Alarm Set Mode, mode changes 2nd Alarm Set Mode or Gas Measure Mode. 2nd alarm set method equals 1st alarm set method.



### Alarm Display







When the 1st alarm occurs, and the operator recognizes it and presses Power key, only the alarm sound stops, remaining LED alarm as the operation stale. When the 2nd alarm happens, the operator and workers should promptly escape from the work site. The alarm do not even stop where the concentration value of gas is normal.**(It need to turn off/on to stop all alarms.)**

When STEL / TWA alarm occurs, it is indicated with the value of the measured concentration and alerts alarms of the same sound of alarm and vibration as that of the 2nd alarm. When STEL / TWA alarm occurs, the icon can be deleted only by Power Off.

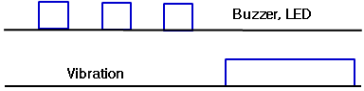
**<Caution>** The value of alarm of the instrument is set according to the alarm standard of each gas that is required by international standard. Therefore alarm value of the relevant gas can be changed under the responsibility and approval of the administrator of the work site where the instrument is used.

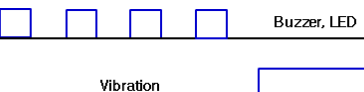
Primary battery alarm sounds repeatedly at 5 minute intervals when only a bar of battery icon is remained. Secondary battery alarm starts right before the end of power, and the power source finishes after 10 seconds from the outbreak of alarm.

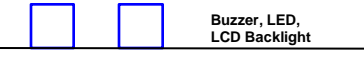
In the event of failure of test or calibration, the  icon is displayed with the sound of alarm.

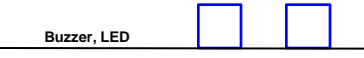
Alarm	Alarm Standard	LCD Display	Alarm & Vibration Display
1 <sup>st</sup> Alarm	In Exceeding Alarm Value Set Primarily	Displaying  Icon & Concentration	
2 <sup>nd</sup> Alarm	In Exceeding Alarm Value Set Secondly	Displaying  Icon & Concentration	
TWA	In Exceeding Exposure Concentration for 8 hour	Displaying Icon <b>TWA</b> & Concentration	
STEL	In Exceeding Exposure Concentration for 15 minutes	Displaying Icon <b>STEL</b> & Concentration	
Dead Battery	Battery Capacity is Exhausted.	 Blinking of Battery	
Test Failure	Failure of Sensor Test Failure of Calibration	Displaying  Icon	

### Alarm Set Point

Gas	O <sub>2</sub>	CO	SO <sub>2</sub>	H <sub>2</sub>	H <sub>2</sub> S	Cl <sub>2</sub>	NH <sub>3</sub>	NO <sub>2</sub>
1 <sup>st</sup>	19%	30ppm	2ppm	100ppm	10ppm	0.5ppm	25ppm	3ppm
2 <sup>nd</sup>	23%	60ppm	5ppm	500ppm	20ppm	1ppm	35ppm	5ppm
TWA	N/A	30ppm	2ppm	N/A	10ppm	0.5 pm	25ppm	3ppm
STEL	N/A	200ppm	5ppm	N/A	15ppm	1ppm	35ppm	5ppm

## 10. Battery & Sensor replacement

When you replace the Battery and sensors of SP2nd, you need some instrument and components as below.

- Instrument : + driver
- Battery : **SB-AA02 (Lithium  $\frac{1}{2}$  AA Battery, 3.6V/1.2Ah)**
- Sensors for replacement : Senko SS series
- Filters for replacement

### <Caution>

1. It is absolutely prohibited to replace battery at potential explosion or dangerous regions.
2. Replacement of components can be damage to intrinsic safety function.
3. The sensors published by SENKO should be used for replacement. Unsuitable function could be shown if another sensors use for replacement.
4. Disassembly should be necessary only for sensors & battery replacement. After the sensor replacement, the span gas calibration should be done.

### Disassembly

- Turn off the power.
- Replace the sensor and battery , please refer to below drawing.
- After replacement, check the sensor fail and battery working.

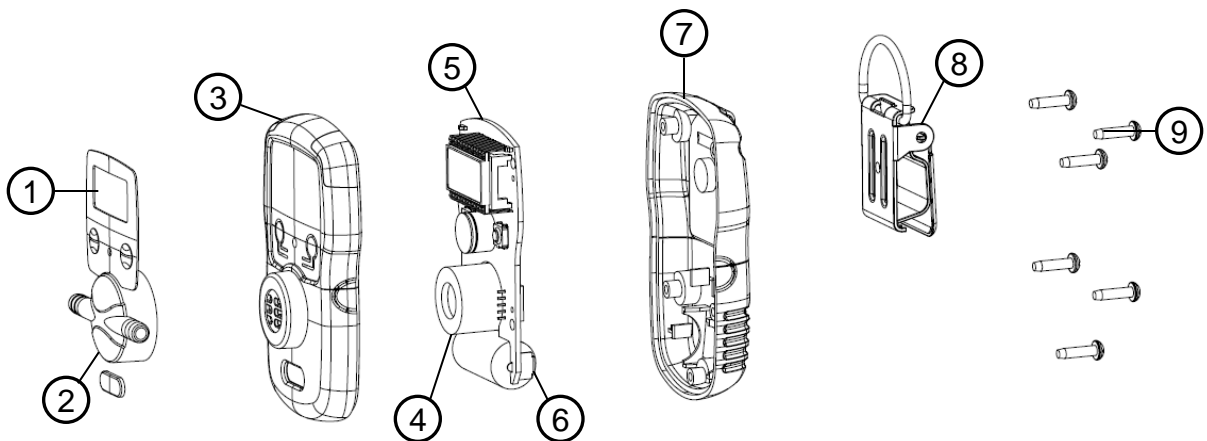

1. Label(Membrane)
2. Calibration Cap
3. Front Cover
4. Sensor
5. PCB
6. Battery
7. Rear Cover
8. Belt clip
9. Machine Screw

# 11. Applicable Battery and External Pump

**<Caution>** It is absolutely prohibited to replace battery at potential explosion areas or dangerous regions. Specification of the applicable rechargeable battery and disposable battery is as below.

- **SB-AA02 (Lithium  $\frac{1}{2}$  AA Battery, 3.6V/1.2Ah)**

If the battery of other specification, It is not permitted to use it for the instrument at dangerous regions

**<Caution>** Explosion can occur, when a battery is thrown into fire or disassembled with force. Disposal of the used battery should be performed according to the guide of the pertinent country or the work site.

## Accessory(Optional) - External Pump (SP-Pump101)s



 key has the function of On/Off, and the state of operation or trouble of the instrument can be recognized by LED lamp. When the leakage measurement or the measurement of concentration by inhalation of gas is required, it is available to measure gas concentration and leakage at the pertinent place by connecting the pump to the instrument. Prior to use, make sure that the instrument is tightly attached to the

probe cover which is connected to the sensor.

**\*\*Please note that External Pump is the optional product that can be provided by the separate order.**

## Product specification(SP-Pump101)

Power Source	AA Size Alkaline Battery(1 EA)
Continuous Operation Time	Available to Operate for 10 hours or longer
Applicable Temperature & Humidity	-20°C ~ +50°C / 5 ~ 95% RH
Exterior	Dimension: 34mm(W) x 270mm(H) x 47 mm(D) Weight: 200g (Including )
Sampling Flux	0.5 liter / minute
Diagnosis Function	Deadlock Alarm, Alert of Insufficient (Red LEC Display)

## 12. Notice for User

Please use the instrument in the range of the applicable temperature, humidity and pressure that are appropriate for the specification of the product. Using the instrument beyond this range may cause malfunction or glitch of the instrument. .

Gas concentration measurement value by the sensor or the instrument can vary according to the environment at site (temperature, pressure and humidity). Therefore the calibration of the instrument should be performed at the same or similar environment as that of the instrument use (temperature, pressure and humidity).

If temperature changes sharply during use of the instrument (for instance, using the instrument at places of far different temperatures between indoor and outdoor), the value of the measured gas concentration can be changed suddenly. Please use it after the gas concentration value is stabilized.

Severe vibration or shock to the instrument may cause the sudden change of value of the measured gas concentration. Please use it after the value of gas concentration is stabilized. Excessive shock to the unit can lead to trouble of the sensor or the instrument.

### Notes on Approval(Label)

<b>SENKO</b> Type : SP2nd
   <b>II 1 G</b>
DNV 10 ATEX 74743
Ex ia IIC T4 IP67
KGS 09-GA2BO-0100(0102)
-20°C ≤ Ta ≤ +50°C
<b>Warning:</b> Only as to intrinsic safety for use in hazardous location. Read manual prior to use.
<b>SENKO Co.,Ltd.</b>
15 Road Oesammiro (485 Oesammi-dong), Osan-si, Gyeonggi-do, 447-230 South Korea
S/N:







**CE marking:** Electromagnetic Compatibility  
(Directive 89/336/EEC)  
Explosion Protection  
(Directive 94/9/EEC)

**KS marking:** Korean Gas Safety for Explosion  
Protection

This device is intended to be used in hazardous area Zone 0 within a temperature range of -20°C to +50°C, where gases of explosion group IIC and temperature class T4 may be present.

**S/N:** Serial Number



		
<b>DET NORSKE VERITAS</b>		
<b>EC-TYPE EXAMINATION CERTIFICATE</b>		
[2]	EQUIPMENT OR PROTECTIVE SYSTEM INTENDED FOR USE IN POTENTIALLY EXPLOSIVE ATMOSPHERES DIRECTIVE 94/9/EC	
[3]	EC-Type Examination Certificate Number:	<b>DNV 10 ATEX 74743X</b>
[4]	Equipment or Protective System:	<b>Portable Single Gas Detector SP2nd</b>
[5]	Applicant – Manufacturer or Authorized representative:	<b>SENKO Co., Ltd</b>
[6]	Address:	<b>3rd floor, Banwol high-tech Village, Won-si dong, Danwon-gu, Ansan-si, Gyeonggi-do 425-852, Korea</b>
[7]	This equipment or protective system and any acceptable variation thereto is specified in the schedule to this certificate and the documents therein referred to.	
[8]	DNV, notified body number 0575 in accordance with Article 9 of Council Directive 94/9/EC of 23 March 1994, certifies that this equipment or protective system has been found to comply with the Essential Health and Safety requirements relating to the design and construction of equipment and protective systems intended for use in potentially explosive atmospheres given in Annex II to the Directive.	
	The examination and test results are recorded in confidential reports listed in section 14.	
[9]	Compliance with the Essential Health and Safety Requirements has been assured by compliance with: <b>EN 60079-0: 2006 and EN 60079-11: 2007</b>	
[10]	If the sign "X" is placed after the certificate number, it indicates that the equipment or protective system is subject to special conditions for safe use specified in the schedule to this certificate.	
[11]	This EC-TYPE EXAMINATION CERTIFICATE relates only to the design and construction of the specified equipment or protected system. If applicable, further requirements of this Directive apply to the manufacturer and supply of this equipment or protective system.	
[12]	The marking of the equipment or protective system shall include the following:	
	 <b>II 1 G Ex ia IIC T4 -20°C ≤ Ta ≤ 50 °C</b>	
	Høvik, 2010-09-14 for Det Norske Veritas AS	
	 (Marianne Spæren) Certification Manager	
Notice: This Certificate is subject to terms and conditions overleaf. Any significant change in design or construction may render this Certificate invalid. The digitally signed and electronically distributed document is the original and valid certificate. Ref.: <a href="http://www.dnv.com/digitalsignatures">www.dnv.com/digitalsignatures</a>		
<small>If any person suffers loss or damage which is proved to have been caused by any negligent act or omission of Det Norske Veritas, then Det Norske Veritas shall not be liable to such person for his proved direct loss or damage. However, this compensation shall not exceed an amount equal to ten times the fee charged for the services in question, provided that the maximum compensation shall never exceed USD 300,000. In this provision 'Det Norske Veritas' shall mean the Foundation Det Norske Veritas as well as all its subsidiaries, directors, officers, employees, agents and any other acting on behalf of Det Norske Veritas.</small>		



No. 2009 - 100

## Safety Certificate

SENKO Co., Ltd.

3 floor, Banwol hitech village, Wonsi-dong 768-5, Danwon-gu, Ansan-si, Gyeonggi-do, Korea

The following product produced by the above company has been authorized for the use of the  Mark as the product has satisfied the safety and health standards stipulated in the article 34 of Industrial Safety and Health Law.

PRODUCT : Portable oxygen detector(SP2117)

TYPE OF PROTECTION : Ex ia IIC T4 IP67

RATING : 3 V Battery(Panasonic CR2)

CERTIFICATION No. : 09-GA2BO-0100

SAFETY CERTIFICATION STANDARDS :

Article 34 of Korea Industrial Safety and Health Law.

CERTIFICATION CONDITION :  $-20\text{ }^{\circ}\text{C} \leq T_a \leq +50\text{ }^{\circ}\text{C}$

26. May. 2010

Approved for issue on behalf of the president : Hae-Duk Jung

Position : General Manager

Signature : 

Korea Gas Safety Corporation



No. 2009 - 102

## Safety Certificate

SENKO Co., Ltd.

3 floor, Banwol hitech village, Wonsi-dong 768-5, Danwon-gu, Ansan-si, Gyeonggi-do, Korea

The following product produced by the above company has been authorized for the use of the KCS Mark as the product has satisfied the safety and health standards stipulated in the article 34 of Industrial Safety and Health Law.

PRODUCT : Portable Toxic gas detector(SP toxic)

TYPE OF PROTECTION : Ex ia IIC T4 IP67

RATING : 3 V Battery(Panasonic CR2)

CERTIFICATION No. : 09-GA2BO-0102

SAFETY CERTIFICATION STANDARDS :

Article 34 of Korea Industrial Safety and Health Law.

CERTIFICATION CONDITION :  $-20\text{ }^{\circ}\text{C} \leq T_a \leq +50\text{ }^{\circ}\text{C}$

26. May. 2010

Approved for issue on behalf of the president : Hae-Duk Jung

Position : General Manager

Signature :

Korea Gas Safety Corporation