

TIM-W260NH

26 Inch Marine Monitor

GENERAL

This specification defines the descriptions for the TIM-W260NH TFT LCD Monitor. TIM series is developed and designed for use in operator display such as Industrial and Marine applications. TIM series are subject to strict quality tests performed both internally and by independent Classification societies in the World such as ABS, BV, DNV, KR, LR, RS and etc.

KEY FEATURES

- 26 inch TFT active-matrix liquid crystal panel
- High Quality TFT with LED Backlight
- 1920 x 1200 resolutions
- Digital DVI-D, Analog VGA Input Signal
- Console Mounting Type
- Power range : 110VAC~230VAC 50/60Hz



GENERAL FEATURE

Section	Specifications
TFT Technology	Active Matrix Liquid Crystal Display Amorphous TFT (Thin Film Transistor) Anti-Glare & Anti-Reflective LED Backlight Technology
Viewable Size	26 inch diagonal
Active Area	554.1mm (H) x 347.8mm (V)
Resolution	1920 x 1200
Pixel Pitch	0.2865 (H) x 0.2865 (V)
Aspect Ratio	16:10
Response Time	20ms
Brightness	350cd/m ²
Contrast Ratio	1500:1
Viewable Angle	178°RL / 178°UD
Max Colors	16.7Million True Color
Synchronization Range	31~80KHz (Horizontal) 55~76Hz (Vertical)
Optimal Resolution	1920 x 1200 @60Hz
Detectable Resolution	640 x 350, 640 x 480, 720 x 400, 800 x 600, 1024 x 768, 1280 x 1024, 1600 x 1200, 1920 x 1080, 1920 x 1200
Input Signal	1 x VGA (D-SUB 15p female) 1 x DVI-D (DVI 24p female) 1 x RS232 (D-SUB 9p female)
Power Specification	110VAC~230VAC 50/60Hz (IEC Standard AC Inlet)
Consumption	50W (MAX)
Product Dimension	660mm (W) x 89mm (D) x 456mm (H)
Weight	15.15kg
Operation Conditions	Temperature : 0°C to +50°C Humidity : up to 95%
Storage Conditions	Temperature : -20°C to +60°C Humidity : up to 95%
Options	Dimming : 0~100%
Test Approval	IEC 60945, IACS E-10
Certification	ABS, BV, DNV, KR, LR, RS

MARINE LCD MONITOR

TIM-W260NH

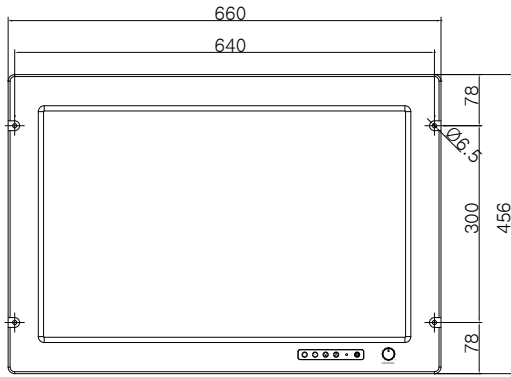

FRONT VIEW



SIDE VIEW

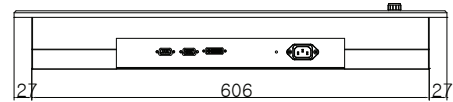

BOTTOM VIEW

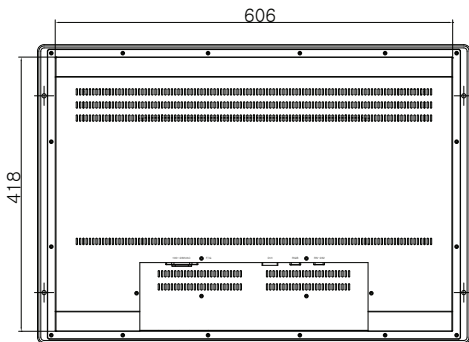

REAR VIEW

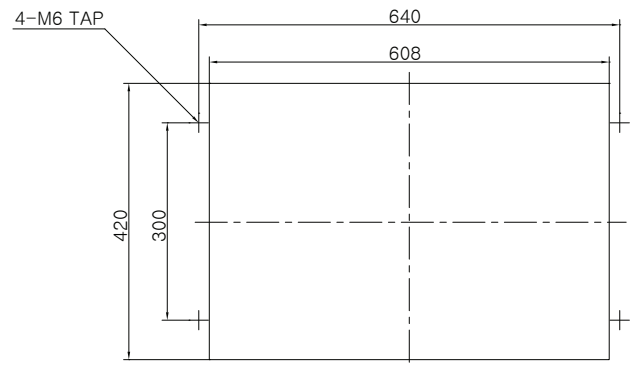

PANEL CUTTING

Tetradyne Co., LTD.

#604/605, E&C VENTURE DREAM TOWER II, 55,
DIGITAL-RO 33-GIL, GURO-GU, SEOUL, 08376, REP KOREA

Tel : +82-2-323-4972

E-mail : sales@tetradyne.co.kr

Web site : www.tetradyne.co.kr

Contact Point

Specifications and features are subject to change without notice.

All products names are trademarks or registered trademarks of Tetradyne.co.,Ltd.