

TIP-150NT

15 Inch Marine Panel PC

GENERAL

This specification defines the requirements for the TIP-150NT TFT LCD Display Panel PC with 1024 x 768 pixels visible resolution, which is designed and tailored for use in operator display and computer operating systems such as Marine computer applications.



KEY FEATURES

- 2nd Generation Intel® Core i3
- Color display 15" TFT LCD Monitor
- 1024 x 768 resolutions
- Resistive Touch screen
- VGA, DP and HDMI Display
- LAN Communication
- Power range : 110~230VAC 50/60Hz or 18~32VDC
- LCD PANEL backlight unit : LED Backlight units

GENERAL FEATURE

Section	Specifications
CPU	2nd Generation Intel Core i3-2310M (2.1GHz, 3M)
System Chipset	Intel QM67 Express
Memory	1 x 4GB Dual DDR3 SO-DIMM
Storage	1 x 128GB SSD
Graphic	Intel HD Intergrated Graphic Engine
LAN	1 x Intel 82579LM / 1 x RealTek RTL8111C Gigabit Network
I/O Connector	4 x USB 2.0 2 x COM (COM1: RS-232/422/485, COM2: RS-232 Only) 2 x RJ45, 1 x VGA, 1 x HDMI, 1 x DP
Display Type	15" TFT LCD PANEL
Color	16.2Million True Color
Resolution	1024 (H) x 768 (V) Pixels
Active Area (Aspect Ratio)	304.128 (H) mm x 228.096 (V) mm (4:3)
Brightness	400cd/m ²
Contrast	1500:1
View Angle (Typ)	170° (R/L) / 170° (U/D)
Response Time	35ms
Touch Type	5 - Wire Resistive Type
OS	Windows 7 Professional
Power Input	110~230VAC 50/60Hz or 18~32VDC
Power Consumption	100W (MAX)
Dimension	402 (W) x 80.8 (D) x 330 (H) mm
Weight	5.4Kg
Graphic Output Connector	VGA, HDMI, DP
Option	Memory - Up to 1 x 8GB Dual DDR3 SO-DIMM Storage - Up to 1 x SSD 1TB OS - Windows XP, Windows XP Embedded, Windows 7 Embedded
Environmental Factors	Operation Temp : 0°C ~ 60°C / Storage Temp : -20°C ~ 80°C / Humidity : 0% ~ 95%
IP-Rating	IP65 Front
Certification	ABS, DNV, KR, LR

MARINE PANEL PC

TIP-150NT

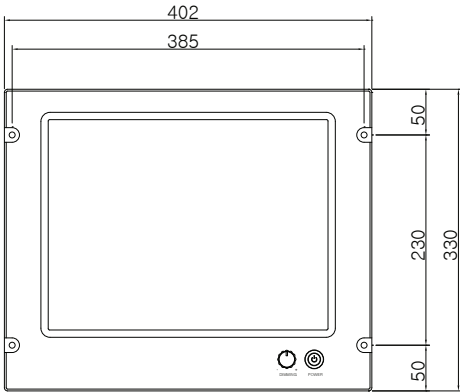

FRONT VIEW

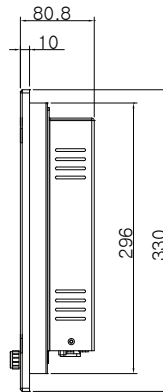

SIDE VIEW

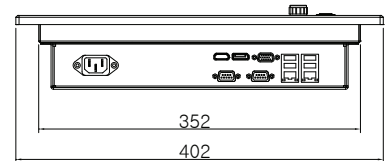

BOTTOM VIEW

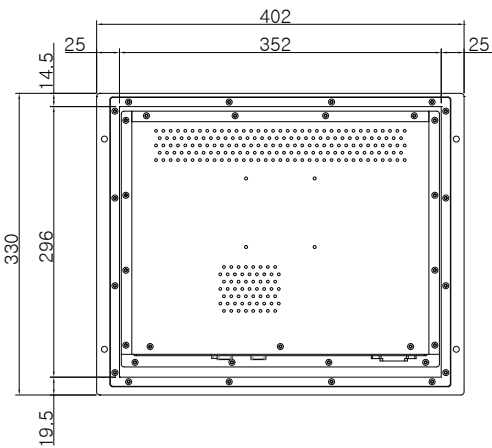

REAR VIEW

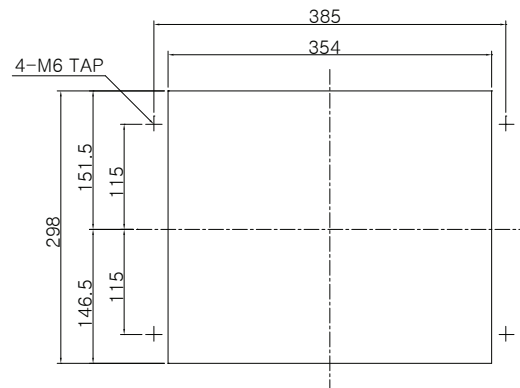

PANEL CUTTING

Tetradyne Co., LTD.

#604/605, E&C VENTURE DREAM TOWER II, 55,
DIGITAL-RO 33-GIL, GURO-GU, SEOUL, 08376, REP KOREA
Tel : +82-2-323-4972
E-mail : sales@tetradyne.co.kr
Web site : www.tetradyne.co.kr

Contact Point

Specifications and features are subject to change without notice.

All products names are trademarks or registered trademarks of Tetradyne.co.,Ltd.