

SavantAA

Genius in its field

Atomic Absorption Spectrometer

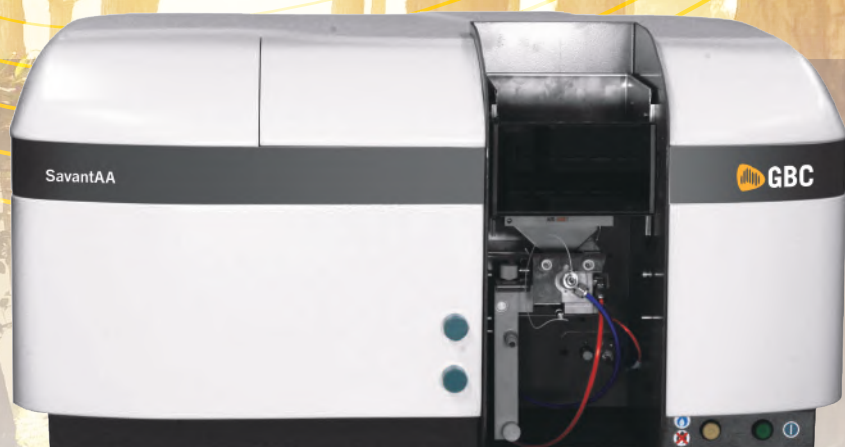



ISO 9001
Quality Accreditation

GBC has always placed a strong emphasis on quality in all aspects of our operation, from design and manufacture to the provision of service and support to our customers, and we are fully committed to continuous evaluation and improvement in all areas.

The GBC Quality Management System has been accredited to the ISO 9001 quality standard by Lloyd's Register Quality Assurance Limited. This certification is your assurance that the procedures and processes used to produce the goods and services which GBC provides comply with the relevant International Standard, and demonstrates commitment to meeting the needs and expectations of our customers.

Since 1978 GBC has been at the forefront of scientific technological development, manufacturing and marketing a wide range of award winning, quality scientific instruments.

GBC's Product lines

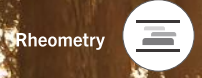

Visionary Technology

GBC Scientific Equipment will advance people's knowledge and their capacity to enhance the quality of life for all humankind.



SavantAA – A wise choice in moving forward in AAS



The SavantAA is the 5th generation AAS from GBC. It draws on a long tradition of excellence in design. The SavantAA atomic absorption spectrometer is a fully automated analyzer capable of handling hundreds of samples per day. There are three SavantAA models, the SavantAA, SavantAA Σ and the SavantAA Z enduro. The SavantAA also comes in a No Flame version without a gasbox allowing a furnace or hydride dedicated analyzer without flame capability. The powerful SavantAA software allows unprecedented instrument control and data manipulation whilst following all the regulatory QC protocols and features that will assist to achieve US FDA 21 CFR Part 11 compliance. All SavantAAs have USB communications for today's computer requirements.

SavantAA and SavantAA Σ

- Guaranteed world-best sensitivity and precision.
- Double beam optics for long term stability.
- Asymmetric modulation which allows more analysis time in sample beam compared to reference beam for low noise. The analytical signal baseline is not influenced by the optical chopper as occurs on competitor's instruments.
- Hyper-Pulse background correction to ensure accurate results.
- Eight-lamp auto turret with auto lamp align for rapid element selection and accurate lamp optimization.
- Automatic wavelength and choice of 20 slit widths between 0.1 and 2.0 nm in 0.1 nm increments in both normal and reduced height for ease of operation.
- An automatic gasbox system with comprehensive safety interlocks.
- Guaranteed D₂ lamp life over 10 times that of competitors.
- Coded Lamp Recognition for both normal hollow cathode lamps and Super Lamps, fitted standard in the SavantAA Σ . (Optional for the SavantAA.)
- New 10 Volt one lamp Super Lamp capability, fitted standard in the SavantAA Σ . Ensures highest sensitivity with low power consumption and low heat output. (Optional four lamps for SavantAA Σ , one or four lamps for SavantAA.)
- Motorized Vertical Only Movement (MVOM) burner/workhead adjuster, fitted standard in the SavantAA Σ . (Optional for the SavantAA.)
- Optional accessories: System 5000 graphite furnace, HG3000 hydride generator, MC3000 mercury concentrator, SDS720 high speed auto sampler and PS720 auto dilutor.



Best Flame Performance

The SavantAA and SavantAA Σ allows greater than 0.9 absorbance and less than 0.5% RSD using 5 ppm copper – on the same measurement.

SavantAA Z enduro

- Unique Variable Magnetic Field Strength between 0.6 and 1.1 Tesla in 0.1 Tesla increments for maximum precision and sensitivity.
- Eight-lamp auto turret with auto lamp align for rapid element selection and accurate lamp optimization.
- Automatic wavelength and choice of 20 slit widths between 0.1 and 2.0 nm in 0.1 nm increments in both normal and reduced height for ease of operation.
- Coded Lamp Recognition for both normal hollow cathode lamps and Super Lamps.
- New 10 Volt Super Lamp capability, fitted standard for one lamp ensures highest sensitivity with low power consumption and low heat output. (Optional four lamp supply available.)
- New Improved design which allows > 1400 firings per tube and lower %RSD.
- Electronic Sample Viewing standard.



Safety and Simplicity

Safety and simplicity with fully programmable flame control

Programmable flame control improves accuracy and ensures optimum gas flows for every element every time you open a method.

The programmable flame control on the SavantAA and SavantAA Σ , offers significant productivity improvements compared to manual or auto gasbox configurations. The added safety features are of real benefit for nitrous oxide-acetylene analyses, or when inexperienced operators are using the instrument.

Gas flow settings are stored along with many other instrument parameters with each method. This ensures that gas flow settings are accurately reproduced every time the method is used resulting in greater analytical accuracy, trouble free operation and time savings.

Gas flow settings may also be optimized for every individual element in a multi-element analysis. These flows are automatically adjusted and flame types can also be changed automatically without any operator intervention. This is particularly important for analyses close to the detection limit.

Flame stability is enhanced because gas flow adjustment is smoothly and continuously variable across the entire operating range. This is achieved by continuously-variable needle valves controlled by micro-stepper motors, eliminating the flame pulsations which will occur in solenoid-operating systems.

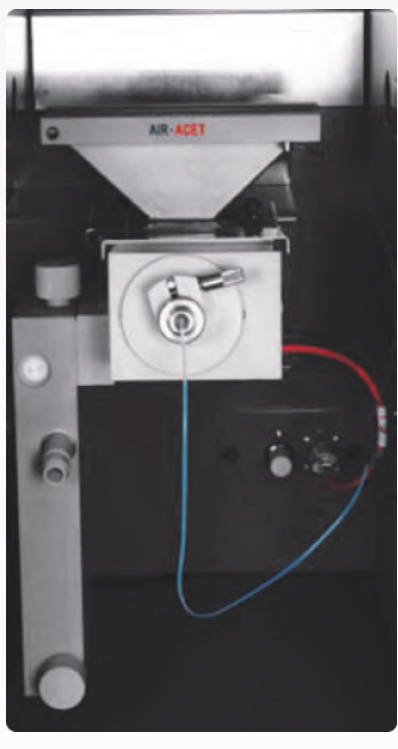

Comprehensive flame control interlocks provide a safer instrument.

Safety without sacrificing any performance is what the SavantAA is all about.

A full range of interlocks ensures trouble free operation even with inexperienced operators.

Safety interlocks include:

- Ignition of flame is prevented if no burner is installed, or is not installed correctly.
- The flame will not change-over to a nitrous oxide-acetylene flame if the correct burner is not installed.
- Pressure sensors on the air, acetylene and nitrous oxide gas supplies continually monitor the pressure so that the flame will not ignite if the pressure is too low, or the flame will be shut down if the pressure drops while it is burning.
- The oxidant flow (air or nitrous oxide) is continuously monitored to ensure that the flame can be ignited or shut down in the correct manner if the flow is insufficient. Insufficient oxidant flow can result in a flashback. GBC is the only company to offer this important safety feature.
- A flame sensor shuts off the gases if the flame is extinguished for any reason. This prevents the laboratory from filling up with gas.
- An integral liquid trap with built-in liquid level sensor prevents ignition or shuts down the flame if there is insufficient liquid in the trap.
- Sensors on both the nebulizer bung and pressure relief bung ensure that they are correctly in place. Ignition is prevented or the flame is correctly shut down if either of the bungs is not correctly positioned.
- A mains power sensor shuts down the flame in the correct sequence if the power supplied to the instrument is interrupted.

Sensitive and Efficient

Unmatched Optical Performance

Optics

The optical design is the heart of any spectrometer, and at GBC we have a long history of quality optical systems.

The large, self-calibrating 333 mm (focal length) monochromator has been specifically designed to provide the high light throughput and stability needed for atomic absorption.

Spectral bandwidth is continuously adjustable between 0.1 and 2 nm (in 0.1 nm increments) and, for furnace work, reduced slit height is available with all slit widths. A wide-range photomultiplier tube covers the full wavelength range (175–900 nm).

The SavantAA range provides unmatched optical performance by:

- The use of the most efficient all-reflective optics (not inferior lenses).
- The use of minimal optical components (to ensure maximum light throughput).
- The monochromator is designed for maximum efficiency for all wavelengths.
- The unique Asymmetric Modulation to improve signal to noise ratio.

Conventional double beam instruments measure the light in both the sample and reference beams for equal duration, Asymmetric Modulation allows the light in the sample compartment to be measured for twice the duration of the sample beam measurement. As the sample compartment is the area in which all the noise is generated in any AAS, Asymmetric Modulation improves the signal-to-noise ratio by as much as 40%. This results in unmatched performance in both sensitivity and detection limit.

Hyper-Pulse background correction

The Hyper-Pulse background corrector, available on the SavantAA and SavantAA Σ – one of the fastest systems available, has been further improved by pulse interpolation. This allows for more accurate interpolation of “Transient Signals” such as GF signals. High intensity deuterium arc lamp

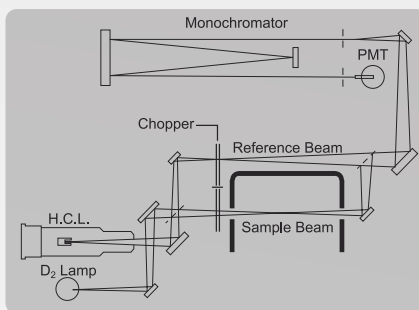

provides 175–425 nm correction range. With all background correction systems, there is a small time delay between the measurement of background and total absorbance.

When the background is changing very rapidly, as is often the case with graphite furnace work, this delay can lead to an error in the background corrected reading. Systems with slower sampling rates and longer delay times show greater errors.

Most background correctors measure the background absorbance 50 or 60 times per second and the delay between the measurement of background and total absorbance can

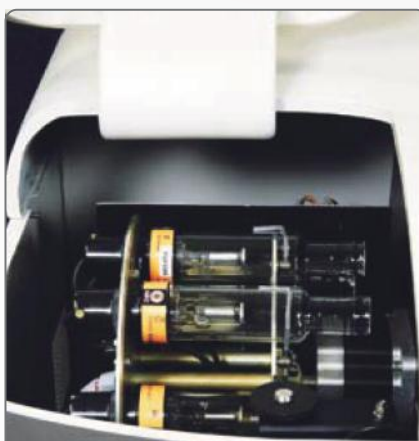

A motorized eight-lamp turret is standard on the SavantAA range. The user simply selects the required element, the rest is automated – wavelength, lamp selection, lamp current, lamp alignment, slit width, slit height and lamp warm-up sequence. Multi-element analysis could not be simpler!

be as much as 10 milliseconds.

The GBC Hyper-Pulse system takes 200 (50 Hz) or 240 (60 Hz) sample measurements per second and the delay between the measurement of background and total absorbance is about 1 millisecond. This produces a dramatic reduction in background correction errors. Accuracy is further improved by interpolating between background measurements to calculate the background when the atomic signal is measured.

This system also allows correction for higher background levels than most systems – up to 2.5 total absorbance.

Extended lamp life

In addition, the design of the high intensity D₂ lamp and associated power supplies ensures unequalled lamp lifetime. The GBC lamp will operate for 1000 hours even at full current. Compare this to some alternative brand instruments where the D₂ lamp is guaranteed to last only 90 hours of operation, and add up the savings! GBC lamps have low lamp current requirement with a high duty cycle design.

Flame atomization system delivers reliability and performance

All materials in contact with the sample have been selected for maximum corrosion resistance. On the SavantAA and SavantAA Σ , the spray chamber is made from inert polypropylene. The burner is made entirely of titanium. The nebulizer has a platinum-iridium capillary and an inert venturi.

The nebulizer also has an adjustable sample uptake rate, essential for optimum performance with refractory elements or organic solvents. The whole flame atomization system is easily removed for cleaning or for change-over to graphite furnace.

Enhanced Dynamic Range

The SavantAA Σ is the sum of all – the top of the range research grade Atomic Absorption Spectrometer.

It has all the features of the SavantAA plus:

- Automated motorized workhead adjustment (vertical and horizontal).
- Automatic Burner Rotation.
- Super Lamp Power Supply.
- Coded Lamp Recognition.
- Electronic Sample Viewing.

Automatic Workhead Adjustment

The automatic burner adjuster provides motorized adjustment in both the vertical and horizontal directions. This is software controlled enabling the burner or accessory to be accurately and reproducibly positioned in the light path every time for optimum performance.

The position is stored with each method so that with an unattended multi-element flame the optimum sensitivity can be obtained for each element. So that if you are analysing air-acetylene for some elements and nitrous oxide-acetylene for others, the correct burner position relative to the optics will always be used. The graph below shows signal optimized individually (blue) compared to signal optimized for Cu (yellow).

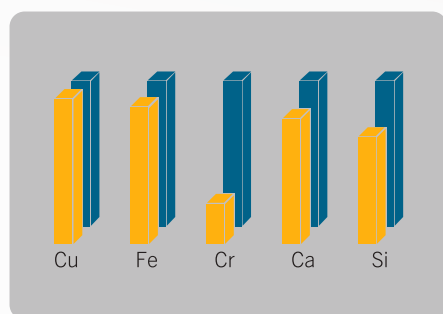

Automatic Burner Rotation

The use of Automatic Burner Rotation has revolutionized the way in which flame AAS analysis is performed. One inherent problem with conventional AAS

analysis is a narrow dynamic range, meaning that samples with a wide concentration range cannot be measured with a single calibration. High concentration samples require dilution which is a time consuming procedure and increases errors associated with the measurement.

Automatic Burner Rotation increases the measurement range by a factor of forty, in some cases eliminating the need for additional sample preparation. In comparison with automatic on-line dilution systems, ABR is at least twice as accurate and up to ten times quicker. This can greatly reduce analyte usage, while improving the productivity of your laboratory.

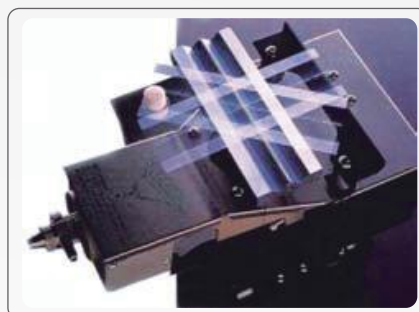

Results for fertilizer and brine samples using Automatic Burner Rotation

Matrix	Element	Actual Conc. (µg/mL)	Meas. Conc. (µg/mL)	% Recovery
Fertilizer	Al	550	550.3	100
Fertilizer	Al	550	536.7	97.6
Fertilizer	Cd	40.07	39.05	97.5
Fertilizer	Cd	40.07	39.29	98.1
10% NaCl	Si	890	889.3	99.9
10% NaCl	Si	890	889.3	99.9

Data for iron measurements comparing automatic burner accuracy with manual dilution accuracy

Actual Conc. (µg/ml)	Measured Conc. Using ABR	% Recovery ABR	Measured Conc. Using Dilution	% Recovery Using Dilution
10.0	10.01	100.1	10.01	100.1
10.0	9.99	99.9	10.17	101.7
200	200.2	100.1	198.3	99.2
200	200.4	100.2	197.6	98.8
200	200.9	100.5	198.1	99.1

Super Lamp Supply

Super Lamps are high intensity hollow

cathode lamps. Elements such as As, Se, Cd, Ni and Pb in particular have improvements in detection limit, sensitivity and linearity.

The SavantAA Σ has one Super Lamp power supply as standard. An optional four Super Lamp power supply is also available.

Element	Standard HCL (µg/mL)	Super Lamp (µg/mL)	Detection Limit Improvement
As	0.5	0.1	5.0
Se	0.4	0.06	6.7
Cd	0.014	0.007	2.0
Pb	0.14	0.05	2.7

When used in conjunction with ABR, the dynamic range can be extended by more than two orders of magnitude.

Coded Lamp Recognition

Simply insert “coded” lamps into the turret and the software recognizes the element and what position in the lamp turret it is located. This feature eliminates any errors which could occur by an operator entering an incorrect element in the lamp table.

Electronic Sample Viewing

The ESV in-line colour video camera allows viewing of the flame or graphite furnace tube in real time. This feature is indispensable when used for graphite furnace method development. The analyst can view the sample as it is injected right up to atomization allowing correct sample deposition, sample drying and ashing to be correctly set for reproducible and accurate results. The colour monitor status panel allows real time viewing.



SavantAA Z enduro

Sets new standards in high performance Zeeman graphite furnace analysis

Unique Variable Magnetic Field Strength (MFS)

A constant magnetic field strength for all elements leads to severe limitations in analytical performance for many sample types. The second generation SavantAA Z enduro achieves optimal background correction and sensitivity by allowing optimization of the magnetic field strength for each element/matrix combination. The applied magnetic field can be varied from a low 0.6 to a high 1.1 Tesla. Once selected, the field strength remains constant for the duration of the measurement. This allows the operator to set the optimum field strength for each element, maximizing the Zeeman Effect as measured through the magnetic sensitivity ratio (MSR) and giving unmatched sensitivity.

Competitor's Zeeman background correction technologies reduce the performance for the primary wavelength for some elements. For example an alternative wavelength for Al must be used to achieve reasonable sensitivity. This difficulty is not encountered with the SavantAA Z enduro. Its variable background correction allows the field strength to be adjusted to maximize both precision and sensitivity. This produces accurate results, every time!



Transverse heating ensures even atomization of the entire sample. The sample is deposited between the two wings which is the hottest part of the tube. The wings have high thermal mass allowing maximum thermal conductivity and uniform heating to the sample.



Accurate background correction

Analysis of environmental samples for trace level analytes requires precise accurate measurement. This is critical where transient background and analyte signals in the graphite furnace change rapidly with time and introduce measurement errors. These difficulties, associated with high background absorbance and structured background are minimized by using the highest speed background correction that the SavantAA offers. (1 ms which is four times faster than most other instruments.) The fast background correction and 200 Hz sampling rate minimizes errors due to slow background correction enabling precise and accurate results.

Advanced furnace design

The efficient furnace design and accurate temperature control provide an optimized environment resulting in consistent performance for extended analysis runs and unattended operation. Furnace ramp rates of up to 2,500°C/sec ensure optimum atomization conditions for refractory elements. All this from a single phase mains connection. Three phase mains is not required! More than 1,400 firings per tube and lower %RSD are now achievable.

Easy access, self aligning tubes

The unique one piece molded workhead features an integrated magnet and graphite furnace controlled by a state-of-the-art power supply. Major advantages of this design include open access to the furnace tube and self-alignment of the tube to simplify furnace cleaning or tube replacement. The tube is horizontally mounted. Heat is directed to centre of tube where sample is. The pivoting furnace clamp assembly is interlocked for safety, preventing operation when the furnace is open. Perfect tube alignment is guaranteed by the unique tube profile which provides a one-way fit and automatic centering of the injection port.

System 5000 delivers sub ppb detection limits

SavantAA and SavantAA Σ Accessories

System 5000

Fully automated high performance System 5000 Graphite Furnace

For analyses where parts per billion detection limit is required, the System 5000 offers the automation, the reproducibility and the accuracy required.

The System 5000 graphite furnace is a complete graphite furnace system which includes the PAL Auto Sampler for rapid and accurate analysis and the power supply unit and workhead. The entire system is controlled by the SavantAA software.

Approximately 50 elements can be determined, most at sub-parts-per billion concentrations.



Features and benefits

- Variable injection volume of 1 μL to 100 μL in 1 μL increments allows the user to setup optimum method.
- Temperature program up to 3,000°C for even the most complex sample.
- High performance furnace tubes with raised sections contain the sample within a small area of the tube to eliminate temperature gradients.
- Programmable gas selection allows different gases to be used allowing for diverse ashing techniques to be used in one method.
- Chemical modifiers are dispensed automatically. Two modifiers are available eliminating almost all manual sample pre-treatment.
- Variable injection speed is a useful feature which is needed with viscous samples such as oils, or when using hot injection.
- Hot injection allows faster analyses and thus greater laboratory productivity.
- Unique setup and storage of PAL probe co-ordinates (horizontal position and vertical position) in the software.
- Multiple injections allow automatic pre-concentration. For low concentration analyses the PAL auto sampler will deposit the sample and the furnace will dry then ash before the cycle is repeated as many as fifty times, totally eliminating messy and time consuming extraction or pre-concentration techniques.



The PAL Programmable Auto Sampler provides automatic calibration with up to 10 standards and automatic analysis of up to 40 samples. Sample volumes between 1 and 100 μL may be selected.

HG3000 and EHG3000 Hydride Accessories

Hydride Accessories

HG3000

Continuous flow HG3000 for best results

The HG3000 is an automatic continuous flow hydride generator for the analysis of the hydride forming elements such as arsenic, selenium, antimony, bismuth, tellurium, tin, germanium and lead at parts per billion concentration level.

The same system can be used to measure mercury at parts per billion concentration utilising the cold vapour technique.

As the system is a continuous flow system, signals can be integrated, thus filtering noise and improving the detection limits when compared to hydride generation systems that produce transient signals. To achieve the same sensitivity with flow injection systems, much larger sample volumes are required, meaning longer set up and analysis times.

The continuous flow process also means faster analysis when following good analytical procedures and measuring more than one replicate. Typical sample throughput is 60 samples per hour, measuring three replicates on each sample. Other systems only allow 30 to 40 samples to be measured each hour when measuring three replicates on each sample. The HG3000 will increase the productivity of your laboratory.



EHG3000

Improve hydride results with the EHG3000 Electrically Heated Hydride Cell

The EHG3000 is used to electrically heat the quartz cell used in hydride generation analysis, as an alternative to flame-heating of the cell. The advantages of using an electrically heated cell include: more accurate temperature control, more stable temperatures, less noise as the flame is not present, and improved detection limits for most elements.

As the EHG3000 does not require a flame, hydride analyses can be carried out unattended or even overnight, saving the laboratory time and money.

In addition, the EHG3000 can be used for warming the cell for cold vapour mercury analysis, eliminating any condensation in the quartz tube.

The electrical heating blanket can also be used with SavantAA No Flame, which does not have a gasbox, enhancing its analytical capability.

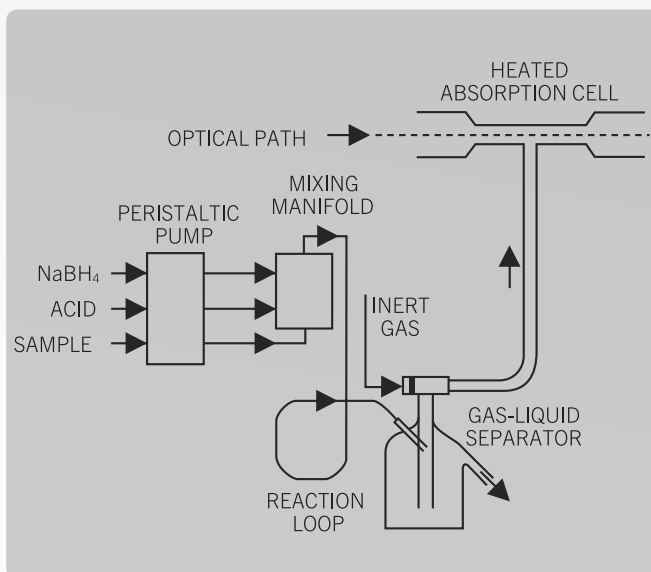

MC3000 and SDS720 Accessories

Mercury analysis at ppt levels

MC3000

Measure mercury at less than 10 ppt with the MC3000 Mercury Concentrator

Regulations for mercury analysis are pushing the required detection limits continually lower, so that they are well below the level achievable using the standard cold vapour technique. The MC3000 mercury concentrator accessory for the HG3000 addresses this problem. By concentrating the mercury vapour on a gold foil, then heating by a patented Radio Frequency, detection limits of five parts per trillion can be readily achieved. The very quick and centralised heating results in the unsurpassed sensitivity and reproducibility. The MC3000 accessory is fully controlled by the SavantAA software and the analysis can be carried out unattended when used in conjunction with the SDS720 auto sampler.

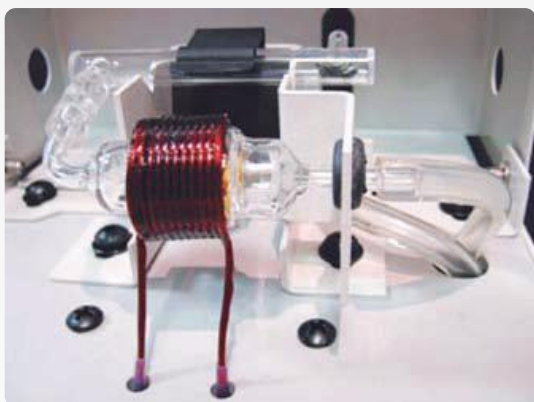

The RF coil surrounds the mercury concentration cell shown in front of the absorption cell located in the light path.

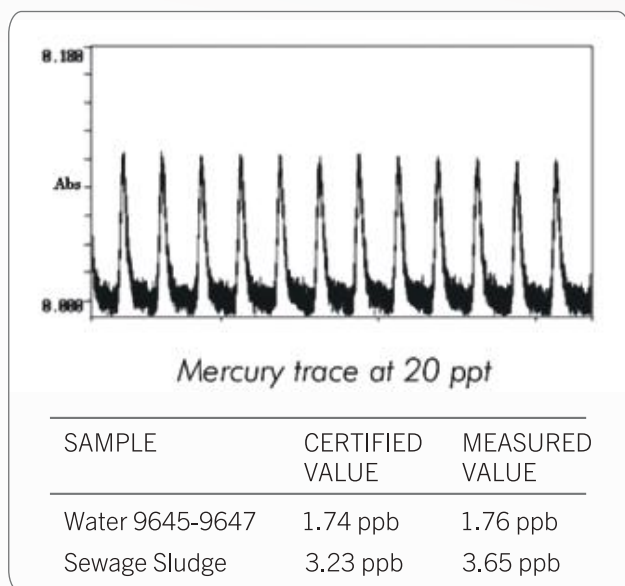

SDS720

Fast, sturdy and reliable auto sampler

The SDS720 is a precision engineered X-Y-Z auto sampler. The SDS720 provides accurate and fast analysis due to its durable, simple, adaptable, reliable and sturdy design. Supplied with sample racks to hold 240 sample vials each of approximately 14 mL and a standards rack to hold 10 standard vials each with a volume of approximately 50 mL. Plastic sample and standard vials are supplied. PTFE and PEEK is used to provide a metal free liquid flow path. Variable continuous flow sample probe rinse station with peristaltic pump minimizes sample contamination and carry-over. An inert spill rack which prevents any solution inadvertently spilling over the auto sampler or your laboratory.

The SavantAA software totally controls rinse time, delay time, number of replicates, rescale rate, recalibration rate, measurement time and analysis order. Full random access capability is standard. Up to 360 samples can be loaded using 7 mL tubes and a further 360 samples using the optional rack extension giving a total of 720 samples.



PS720

Fast, sturdy and reliable dilutor

The PS720 is used in combination with the SDS720 auto sampler, removing the need for manual standard and sample preparation and sample dilution for flame and hydride applications. The PS720 is totally controlled through the SavantAA software enabling true fully-automated analysis. Simple and reliable automation of standard additions and spike recovery, or sample matrix modification through the addition of up to two chemical modifier solutions provides hands-off operation and versatility. The ability to work in combination with Automatic Burner Rotation (ABR) extends the dynamic range beyond that of other dilution systems.

Easy to use Software

Powerful Windows® AAS Software

The best AAS software just got better

The design of the SavantAA software was guided by several requirements expressed by AAS users. High on the list was ease of use, and the graphical environment of Windows® was an obvious choice. Good software design ensures that comprehensive and powerful features do not compromise the simplicity of method setup or sample measurement, and that prompt and appropriate access to help is provided when needed.

The new SavantAA software addresses these requirements with a complete easy-to-use package. For instance, the software requires only one mouse click to initiate an analysis. The structure of the program ensures that method, sample identification, analysis, report generation, instrument setup and results are clearly separated and easily accessible. On-line help explains every aspect of hardware setup, operation, maintenance and safety. Learning to use the instrument is made easy through multi-media tutorials. While running a tutorial or displaying context sensitive help the operator can work through the SavantAA software to build an application, using as much or as little help as may be required. The Windows® platform offers advantages of speed, power, compatibility with third party software and true 64-bit pre-emptive multi-tasking.

Rapid method development

The method module of the software allows the operator to setup and store all parameters associated with an elemental analysis including instrument, quality control, calibration, flame and graphite furnace, sampling and measurement parameters. As all the parameters are within one module it is a simple task to develop a method. Once an element is selected from the periodic table and the appropriate wavelength determined, recommended conditions are recalled. Methods can be password protected to ensure that unauthorized changes or erasure cannot take place.

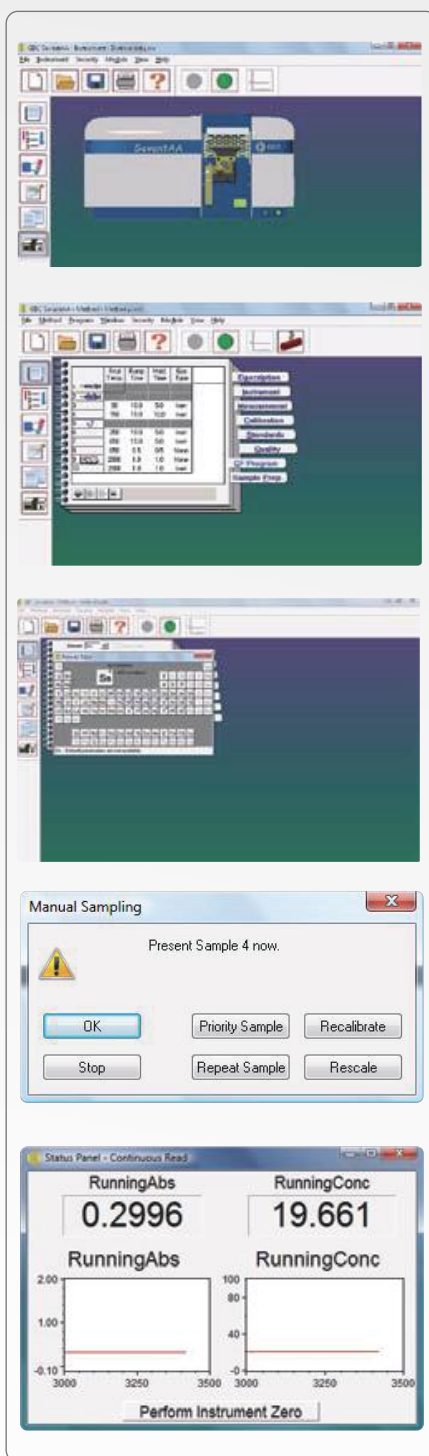

Flexible sample handling

The samples module is used to identify the samples and to determine in which order they will be analysed, when and

how often spike recoveries, check samples, re-calibrations and re-slopes will be carried out.

Once a sample file has been created it can be saved for later use or modification. Also included with the sample identification are sample weights and dilutions which can be used to calculate the element concentration in the original sample. The weights can be read in directly from an electronic balance with a USB port or the information can be imported from other software packages.

Automated multi-element analysis

The analysis module is used to bring together the method and sample details for the measurements that are to be taken. These may be linked to provide fully automated multi-element analysis. This information can be saved as individual files, and multi-element analysis can be initiated with just three mouse clicks.

Result integrity is assured

The results section of the software is used to collect, display and process data collected by the instrument. As all the raw data is collected for each standard and sample it is possible to re-calculate results post-run, based on different criteria. For example, results that were collected in peak area mode can be calculated in peak height mode. This can be invaluable for method development, particularly in furnace work.

The calibration routine can also be changed post-run to get the best possible fit of the calibration. Even weight and dilution data can be added after the analysis and results recalculated. Of course, erroneous results can be deleted, meaning that samples or calibrations need not be repeated. The entire results section can be password protected to ensure the integrity of the data.

Customization

Powerful Windows® AAS Software

Complete instrument diagnostics

The instrument module independently controls all hardware functions of the instrument, from initial setup to optimization and diagnostics. It can be an invaluable tool for problem solving, method optimization and trouble-shooting, saving valuable time and money for your laboratory.

Customized reports

Comprehensive reports have never been easier to generate and customize in either the single element format or as a combined multi-element report. A single element report can contain any combination of information including replicates, calibration graph, method parameters and weights and volumes. All reports can include page footers and headers, individual margins, separate header file, and all columns and rows of information can be individually sized. In addition a full selection of fonts and font size is available. Reported data may be easily and automatically exported to third party software packages, online and post analysis.

Quality control for Good Laboratory Practice

At GBC we realise how important it is for your laboratory to be able to assure the quality of the data it produces. To this end, GBC has incorporated extensive quality control protocols into the software. They include:

Upper and lower limits for quality assurance of samples, ideal for situations where your lab is running samples that have to fall within a pre-determined range. Samples outside the specified range will be flagged.

Check sample analysis. Once a check sample of known concentration has been analysed, further analysis is dependent on the result of the check sample. If the check sample falls within an operator-selected range then the analysis will proceed as normal. If the check sample should fall outside the selected range then the analysis will follow a pre-selected action. Possible actions include: stop, continue and flag, re-slope and continue, re-calibrate and continue, re-slope and repeat all the affected samples or re-calibrate and repeat all the affected samples.

Spike recovery samples allow for sample measurement followed by the analysis of a spiked sample as a check for possible interferences. If the spike fails a pre-determined recovery range then the analysis will proceed according to the procedure specified by the operator. The choices available include all those available for check sample error.

Sample blank is used when the standards and samples

have different matrices and so may require separate blanks.

Calibration fit gives the operator the option of pausing if the calibration has failed an operator-determined curve fit criteria.

Automatic re-slope rate can be set either as a function of time or of the number of samples being analysed, thus further ensuring data quality.

Automatic re-calibration rate can also be set either as a function of time or of the number of samples that have been analysed.

Automatic Sensitivity Correction (ASC) is a unique feature which provides automatic compensation for sample results affected by changes in conditions during an analytical run (for example, aging of a graphite furnace tube). It means that samples need not be re-analysed and that re-calibrations only need to be performed when required. The productivity improvements and savings on consumables using ASC can make a significant difference to your profitability.

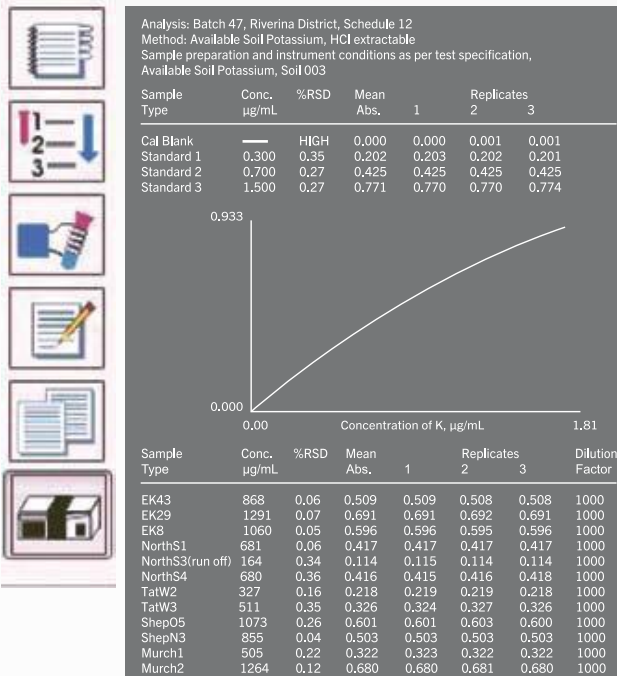

Powerful Windows® AAS Software

Electronic Records and Signatures

The Electronic Records and Electronic Signatures Rule (21 CFR Part 11) was established by the USA FDA to define the requirements for submitting documentation in electronic form and the criteria for approved electronic signatures. This rule defines the standards by which an organization can use electronic records to meet its record keeping requirements. The SavantAA software includes features that will assist to achieve 21 CFR Part 11 compliance.

Security settings allow for the application of an "Audit Trail File". This creates a log of every action carried out by the software and by which user.

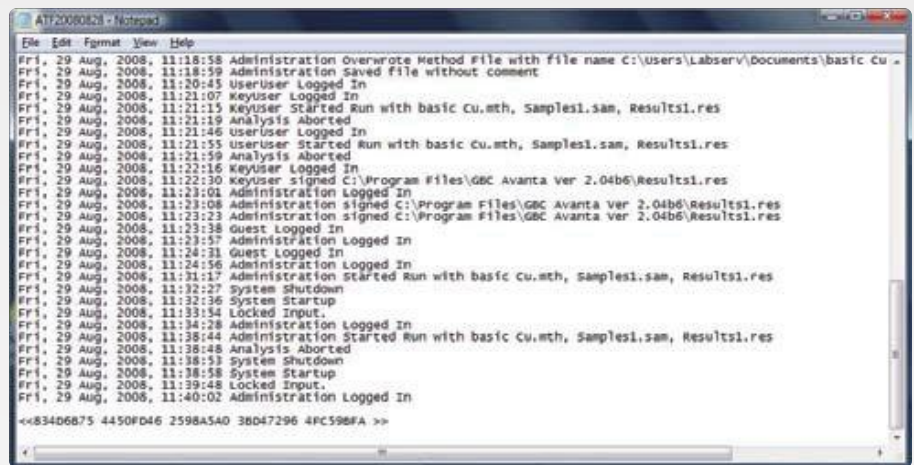

User Password

Selected users may be restricted to a minimal amount of access within the software and prevent the accidental deletion of important files by other users.



Turn Key Solutions

This feature allows a shortcut to the SavantAA software from the windows desktop. This shortcut can be modified so that a specific method, sample, result, or any other files can be opened automatically when the icon is clicked.

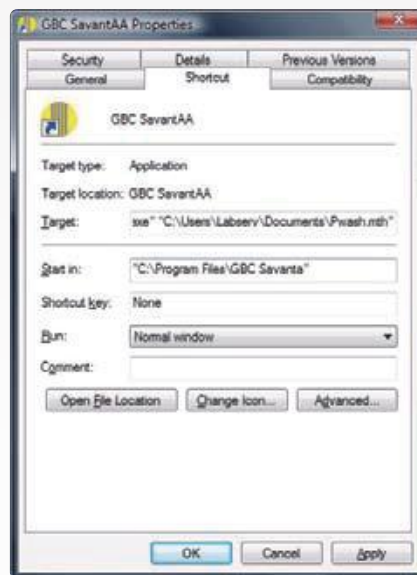

Intelligent Lamp Warm Up

The SavantAA software calculates the exact time when the next element lamp should start to be warmed. This feature saves you money by not having a lamp in warm up mode longer than it needs to be; which can occur during long furnace programs and/or if you have many samples.

Lamp Life Log

The SavantAA software package automatically records lamp life, in mHours, as a text file named "lamplife.log" in the SavantAA program folder. Whenever you change a lamp all you need to do is to reset the log and it will automatically keep track of the number of mHours the lamp has done. Additionally you may setup a status panel whereby you can view the lamps mHour usage any time during the course of the day.



Analysis Time Remaining

Based on the analysis type (flame or furnace program selected), the number of elements, the number of samples selected, rinse times etc., the SavantAA software calculates the time remaining until the end of the analysis. This time can be continuously displayed on a status panel. This informative tool allows a user to know exactly when the current analysis will finish, enabling them to plan their next batch of samples or the next analysis.

SavantAA Specifications

Optics

Double beam with background correction and flame emission capability. Asymmetric modulation with 2:1 sample-to-reference ratio for noise reduction. All-reflective system with quartz overcoating on mirrors. Sealed against dust and vapour. ESV is supplied standard on the SavantAA Σ and SavantAA Z enduro, and is optional on the SavantAA.

Monochromator

Ebert-Fastie design with 333 mm focal length and 175–900 nm wavelength range. 1800 line/mm holographic grating with dual-blazed profile and 1.6 linear reciprocal dispersion. Automatic wavelength selection and peaking. Continuously adjustable slits with 0.1 to 2 nm spectral bandwidth (0.1 nm increments). Reduced height for furnace operation available with all slit widths. Automatic setting of slit width and height. Automatic scanning. Selected wide range multi-alkali photomultiplier tube.

Lamp Turret

Eight-lamp turret with automatic lamp selection. Automatic optimization in two planes for maximum light throughput. Automatic multi-element operation, with the next lamp in the sequence automatically warmed up. Compatible with standard hollow cathode lamps. Coded Lamp Recognition for ALL lamps and one lamp Super Lamp power supply are standard on SavantAA Σ and SavantAA Z enduro and optional on SavantAA. Four lamp Super Lamp power supply is optional on all models.

Background Correction

Hyper-Pulse background corrector on the SavantAA and SavantAA Σ takes 200 (50 Hz) or 240 (60 Hz) sample readings per second for correction of fast background peaks. With approximately 1 ms between pulses and interpolation between measurements, the best possible accuracy is assured. High intensity deuterium arc lamp provides 175–425 nm correction range. Corrects to 2.5 total absorbance. The SavantAA Z enduro also has the fastest background correction of any longitudinal Zeeman of 1 ms between sample and background measurement.

Programmable Flame Control

Automatic setting of flame type and gas flows from stored conditions. Programmed ignition and shutdown sequences. Automatic change of flame conditions during automatic multi-element operation. May be programmed to automatically extinguish the flame at the end of an analysis. Interlocks monitor air, acetylene and nitrous oxide pressure, burner presence, burner type, liquid trap level, presence of nebulizer and pressure relief bung, oxidant flow, flame condition and mains power. Ignition is prevented or flame is shutdown if a fault is detected. Screen display of interlock status.

Flame Atomization System

Pre-mix design with solid inert polymer mixing chamber. All-titanium burner construction. The optional nitrous oxide burner is designed to reduce carbon build up. Nebulizer has platinum-iridium capillary and inert venturi for resistance to acid attack. Adjustable sample uptake rate with locking mechanism. Inert impact bead. Interlocked nebulizer bung and pressure relief bung. Integral liquid trap with liquid level interlock. SavantAA and SavantAA Σ have quick-change mounting to enable easy change-over to graphite furnace. SavantAA Σ has automatic motorized height and horizontal adjustment of the burner and graphite furnace workhead.

Automatic Burner Rotation

The SavantAA Σ has motorized burner rotation allowing the burner angle to be set as part of a method. Samples outside the calibration range can be automatically re-measured at a greater angle after a further calibration. Angle is settable to $\pm 0.1^\circ$ with a rotation angle from 0° to 90° . This feature is an option on the SavantAA.

Performance Guarantee

Greater than 0.9 abs for 5 mg/L copper solution with an RSD of less than 0.5% on the same measurement for the SavantAA and SavantAA Σ .

Minimum PC Requirements

An IBM compatible computer incorporating an Intel® Pentium® or AMD CPU technology. A minimum of 1 GB RAM, four USB ports, a minimum of 50 GB data storage capacity, USB mouse and 101 key keyboard.

Dimensions

960 x 610 x 490 cm (W x D x H)

Weight

SavantAA and SavantAA Σ
Unpacked 70 kg, Packed 127 kg
SavantAA Z enduro
Unpacked 95 kg, Packed 136 kg

Electrical Requirements

100–240V AC, 50/60 Hz, 600 VA

Software

Microsoft Windows® operating system for true multitasking. Controls SavantAA and SavantAA Σ and all its accessories: SDS720 auto sampler, PS720 auto dilutor, GF5000 graphite furnace and PAL furnace auto sampler and MC3000 mercury concentrator.

Controls the SavantAA Z enduro and its accessory: PAL4000.

Data Processing

Provides analysis by atomic absorption or emission. Absorbance range to 3.0 Abs. Measurement by integration, running mean, peak height or peak area. Mean and RSD of up to 50 replicate readings. Calibration using up to 10 standards. Linear least squares curve correction, linear least squares through zero curve correction, exact fit curve correction, concentration least squares (polynomial) curve correction, standard additions or bracketing standards. Programmable reslope using a single standard or complete re-calibration, rate settable by either time or frequency of samples. Password protected result editing to remove unwanted readings on either samples or standards. Weight and dilution correction. All editing available either during the run or post run.

Graphics

High resolution colour display of atomic absorbance, background signals, furnace temperature programs, calibration curves, peaking meters and wavelength scans. Graphics can be displayed in a number of different modes including overlaying non-successive peaks. Selectable absorbance scale for traces. Graphics cursor can be used to obtain numerical information from graphics traces. Zoom function allows graphics traces to be expanded.

Data Storage

Storage is provided for all data including the linking of the graphics trace to the result. Also stored are the methods, sample labels, sample sequences, method sequences, weights and dilutions, report headers and footers, calibrations and the results.

Report Generation

Reports may be printed from all stored results in either single element or multi-element format with results being combined from different runs and different measurement techniques. All operating parameters, calibration graphs, headers, footers, method notes, sample labels, results statistics and weight and dilution factors may be printed. Software supports a full range of printers.

Quality Control Protocols

Complete range of quality control functions available including check samples, spike recovery, upper and lower QC limits, calibration correctness. Checks can be carried out at pre-determined intervals based on time or number of samples analysed. Alternately checks can be carried out randomly. All checks have operator settable failure limits and failure actions. Flagging for all failed tests.

SavantAA and SavantAA Σ Accessories

System 5000 Graphite Furnace

Automated graphite furnace system. Comprises GF5000 graphite furnace power supply and workhead plus PAL programmable furnace auto sampler. Controlled by GBC SavantAA software.

GF5000 Furnace Assembly

Furnace assembly includes graphite tube (and platform if required) mounted in enclosure with quartz windows. Permanently connected to power supply by umbilical cord carrying gas, cooling water and electrical supplies. Two independent gas supplies. Temperature range ambient to 3000°C. Computer controlled maximum heating rate of 2000°C/sec.

Unlimited number of steps, each with ramp and hold, gas selection, graphics display option and read option.

Temperature controller monitors current and voltage and uses power feedback to provide accurate control over the full temperature range during both ramp and hold stages. Interlocked to inert gas and cooling water pressures. Corrects for changes in cooling water temperature.

PAL Furnace Auto Sampler

Accommodates 40 samples and 10 premixed standards and one stock solution for automatic mixing of up to 10 standards. Container volumes are 2 mL for samples and standards, 5 mL for automix standard, 10 μ L for blank and primary modifier. Auxiliary modifier can be placed in any position on the auto sampler. Dispensed volume is 1–100 μ L, programmable in 1 mL increments. All-PTFE capillary, 1 L rinse container. Probe set-up controlled by computer with co-ordinates stored in memory. Program options include automatic mixing of standards, automatic injection of chemical modifier(s), multiple injection, heated injection, automatic re-slope or complete re-calibration, check sample, and spike recovery.

Inert Gas Requirements

Argon or nitrogen at a pressure of 70–200 kPa (10–30 psi)

Cooling Water Requirements

1–2 L/min at 100–200 kPa (15–30 psi)

Dimensions

GF5000: 410 x 370 x 329 mm (W x D x H)
PAL: 220 x 209 x 140 mm (W x D x H)

Weight

GF5000: Unpacked 40 kg, Packed 50 kg
PAL: Unpacked 7 kg, Packed 10 kg

Electrical Requirements

208–240 V AC, 50/60 Hz,
Rated current 15 A, surge current 40 A

SDS720 Auto Sampler

Precision engineered auto sampler. Accurate, durable, simple, adaptable, reliable, fast and sturdy design. Supplied with sample racks to hold 240 sample vials each of approximately 14 mL and a standards rack to hold 10 standard vials each with a volume of approximately 50 mL. Plastic sample and standard vials are supplied. PTFE and PEEK is used to provide a metal free liquid flow path. Variable continuous flow sample probe rinse station with peristaltic pump minimizes sample contamination and carry-over. Software controls include rinse time, delay time, number of replicates, rescale rate, re-calibration rate, measurement time and analysis order. Full random access capability is standard. Up to 360 samples can be loaded using 7 mL tubes and a further 360 samples using the optional rack extension giving a total of 720 samples.

Dimensions

520 x 250 x 482 mm (W x H x D)

Weight

SDS720: Unpacked 11 kg, Packed 15 kg

Electrical Requirements

100–240 V AC, 50/60 Hz

PS720 Auto Dilutor

A syringe pump dilution system for flame and hydride applications. Can be used for automated sample dilution, preparation of working standards and standard additions, addition of chemical modifier solutions, automated spike recovery. Can also be used in conjunction with Automatic Burner Rotation for extended dynamic range.

Dimensions

140 x 330 x 140 mm (W x H x D)

Weight

PS720: Unpacked 7 kg, Packed 9 kg

Electrical Requirements

100–240 V AC, 50/60 Hz

HG3000 Hydride Generator

The HG3000 is an automatic continuous flow hydride generator for the analysis of the hydride forming elements such as arsenic, selenium, antimony, bismuth, tellurium, tin, germanium and lead at parts per billion concentration level.

The same system can be used to measure mercury at parts per billion concentration utilizing the cold vapour technique.

Dimensions

300 x 200 x 260 mm (W x H x D)

Weight

HG3000: Unpacked 7 kg, Packed 12 kg

Gas Requirements

High purity argon or nitrogen at 30 mL/min (+120 mL/min for SnCl₂ operation) and an inlet pressure of 150 kPa

Electrical Requirements

100–240 V AC, 50/60 Hz, 120 VA

MC3000 Mercury Concentrator

Gold amalgamation mercury trapping accessory for use with the HG3000 to enable ppt analysis of mercury. Consists of a power supply and workhead with built-in gold foil trap and quartz absorption cell. Controlled by the SavantAA software. Programmable load time, number of replicates, flush time and clean.

Dimensions

260 x 160 x 290 mm (W x H x D)

Weight

MC3000: Unpacked 11 kg, Packed 15 kg

Gas Requirements

High purity argon or nitrogen gas purge, flow rate 30 mL/min and inlet pressure of 150 kPa.

Electrical Requirements

100–240 V AC, 50/60 Hz

EHG3000 Electrically Heated Cell for HG3000

Temperature controlled electric heating blanket for heating the quartz cell used in hydride generation AAS. Includes power supply with temperature controller and workhead.

Dimensions

260 x 160 x 290 mm (W x H x D)

Weight

EHG3000: Unpacked 4 kg, Packed 8 kg

Electrical Requirements

100–240 V AC, 50/60 Hz

Ordering Information

99-0579-00	SavantAA Σ		
99-0578-00	SavantAA	99-5005-00	Graphite Furnace
	Each SavantAA is supplied with air-acetylene burner, spray chamber, adjustable inert nebulizer, gas hoses, operation manual, flame methods manual and SavantAA software for the operation of the instrument and all accessories.		System 5000 Automated Graphite Furnace System (complete) Comprises GF5000 power supply and workhead plus PAL automatic sampler. Supplied complete with 10 pyrolytically coated graphite tubes, 5 platforms, 500 sample vials, furnace methods manual, beakers, hoses, cables and tubing
99-0576-00	SavantAA No Flame		
	Each SavantAA No Flame is supplied with operation manual and SavantAA software for the operation of the instrument and all accessories.		
	Accessories		
97-5058-00	Motorized Vertical Only Movement (MVOM) burner/workhead adjuster	99-0059-00	Graphite furnace tubes, pyrolytically coated (pack of 10)
99-0273-01	Nitrous oxide-acetylene burner for SavantAA Σ	99-0060-00	Pyrolytic graphite platforms (pack of 10)
99-0075-00	Nitrous oxide-acetylene burner for SavantAA	99-0342-00	Pyrolytically coated, integrated platform graphite furnace tubes (pack of 10)
95-0013-00	Recommended spares and consumables for SavantAA Σ	99-0061-00	Pair of electrodes
95-0103-00	Recommended spares and consumables for SavantAA	99-0022-00	Sample vials for PAL (pack of 500)
99-0012-00	Fume extraction system (complete) 220/240 V, 50 Hz	95-0015-00	Recommended spares and consumables for System 5000
99-0012-01	Fume extraction system (complete) 110 V, 60 Hz	96-0104-00	Refrigerated cooling system 220 V, 50Hz*
99-0400-00	Fume extraction system (complete) 220 V, 60 Hz	96-0104-01	Refrigerated cooling system 115 V, 60 Hz*
75-0054-00	Air compressor 220/240 V, 50Hz		
75-0055-00	Air compressor 110 V, 60Hz	99-0706-00	SavantAA Z enduro (One Super Lamp)
75-0056-00	Air compressor 220 V, 60Hz	99-0707-00	SavantAA Z enduro (Four Super Lamp)
99-0050-02	Nitrous oxide cylinder regulator with heater 220/240 V		Each SavantAA Z enduro is supplied with a PAL4000, hoses, operation manual, furnace methods manual and SavantAA software for the operation of the instrument and the PAL4000
99-0050-03	Nitrous oxide cylinder regulator with heater 110 V		
99-0099-00	Air cylinder regulator		
99-0100-00	Acetylene cylinder regulator		
99-0284-00	Balston gas purifier		
95-9912-00	Gas purifier maintenance kit		
	Flame Auto Sampler	45-0012-00	Graphite furnace tubes, pyrolytically coated
99-0582-00	SDS720 Auto Sampler	99-0022-00	Sample vials for PAL4000 (pack of 500)
	Supplied complete with test tubes, inert probes, cables, tubing, in built wash pump, fixed wash reservoir and four 60-position sample racks.	95-0405-00	Recommended spares and consumables for SavantAA Z enduro
99-0597-00	PS720 Auto Dilutor	95-0406-00	Recommended spares and consumables for PAL4000
	Hydride		
99-0276-00	HG3000 Automatic Hydride Generator		
95-0016-00	Recommended spares and consumables for HG3000		
99-0237-11	EHG3000 Electric Heater for hydride cell		
99-0245-11	MC3000 Mercury Concentrator Unit for HG3000		

*Can also be used with SavantAA Z enduro

Designed and manufactured by GBC Scientific Equipment Pty Ltd
A.C.N. 005 472 686
GBC reserves the right to change specifications without prior notice
GBC publication number
01-1006-02 October 2016

GBC SCIENTIFIC EQUIPMENT
Manufacturer of world-class scientific instruments and accessories
— AAS, HPLC, ICP-OES, ICP-TOFMS, Rheometry, UV-Vis and XRD

4 Lakewood Boulevard
Braeside, Victoria 3195
Australia

Telephone: +61 3 9588 6666
Fax: +61 3 9588 6677
Email: gbc@gbcsci.com
Web: www.gbcsci.com

All trade-marks and trade-names are the property of their respective owners.

